

**theben**

307347

**EN** Clock thermostat

**RAMSES BLE OT**  
8509150



**1. Basic safety information 3**

**2. Proper use 3**

**Disposal 3**

**3. Installation 4**

**Mounting the clock thermostat 4**

**Dismounting the clock thermostat 6**

**4. Connection 6**

**Terminal layout 7**

**5. Manual setting at the clock thermostat 7**

1. Quick selection of comfort or eco mode 8

2. Pairing 8

3. Reset 8

## 6. Settings and functions – operation via Theben app 9

Is my smartphone BLE capable? 9

RAMSES BLE app 9

Connecting clock thermostat and smartphone (via app) – pairing 10

Program  12

Info  14

Settings 15

## 7. Technical data 25

## 8. Contact 25



# 1. Basic safety information

## NOTE

- Connection and installation should only be carried out by a qualified electrician!
  - Before installation/dismounting, disconnect the power supply!
- 
- The clock thermostat conforms with EN 60730-2-9 if correctly installed
  - Corresponds to type 1 STU in accordance with IEC/EN 60730-2-7
  - Operation and programming only via **RAMSES BLE** app
  - With external input (SELV, programmable)

# 2. Proper use

- Heating control for time-dependent monitoring and control of room temperature in single-family houses, offices etc.
- Use in dry rooms with normal levels of domestic cleanliness

## Disposal

- Dispose of device in environmentally sound manner

## 3. Installation

### Mounting the clock thermostat



Electrostatic discharge!

Caution, sensitive electronic components!

When fitting, observe ESD safety measures (electrostatic discharge).



Position the clock thermostat on an internal wall, at about eye level.



Avoid drafts or heat emission.

① For wall mounting



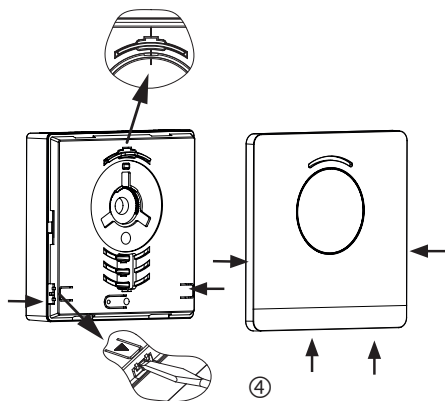
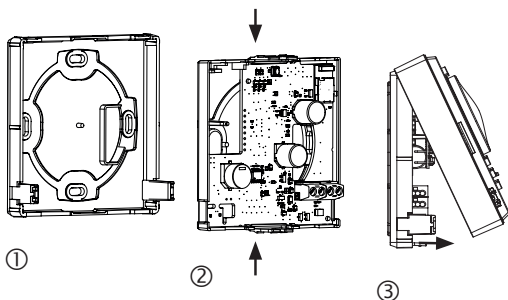

- Attach the mounting plate above the wall outlet of the OpenTherm line ①.
- Engage and wire the circuit board carrier ②.
- First, hook in the upper part of the clock thermostat on top, then engage ③.
- Put on the cover ④.



## Dismounting the clock thermostat

- Using a screwdriver, loosen the front panel at the two side and bottom openings ④.
- Then release the catches on the left and right and remove the upper part of the housing ③.
- Loosen the plug-in connectors and press the circuit board carrier together at the top and bottom ②.
- Remove the circuit board carrier through the front.

## 4. Connection

- The power supply from the thermostat to the boiler is provided via OpenTherm.
- The two-wire connection (OpenTherm) is not polarised, i.e. the wires can be connected to the boiler as required.

 Disconnect the boiler from mains supply before connecting the thermostat.

 Faulty connections will damage the device.

 Without interference, the bus line can be extended up to 50 m.

 In order to eliminate the possibility of EMC interference, always lay the feed of the supply voltage separate from the mains cables.

# Terminal layout

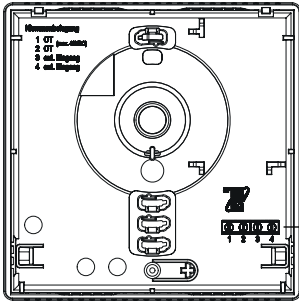

- 1 OT
- 2 OT
- 3 ext. input
- 4 ext. input

## 5. Manual setting at the clock thermostat

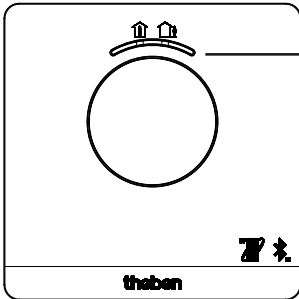

- Button with LED display for setting
  - Comfort mode (green LED on)
  - ECO mode (green LED off)

By using the button, the following functions can be set:

# 1. Quick selection of comfort or eco mode

- ▶ Press the button  
→ Comfort mode or eco mode will be set.

At the next switching time, the quick selection will be reset.

## 2. Pairing

- ▶ Press the button for 3 s  
→ RAMSES BLE OT can be connected with a smartphone/ tablet (paired) for 5 min. (green LED flashes). If pairing is successful, the LED goes out.

### Delete pairing

- ▶ Press the button for 6 s  
→ All connections saved in the RAMSES BLE OT (pairing) will be deleted (red LED flashes)
- ▶ Delete the connection/pairing also on the smartphone/ tablet (Settings → Bluetooth pairing → delete respective device (RAMSES BLE OT)).  
The PIN will be reset to 0.

## 3. Reset

- ▶ Press the button for 12 s  
→ Hardware reset (the red LED goes out)





## 6. Settings and functions – operation via Theben app

### Is my smartphone BLE capable?



► Download Bluescan app for Android and iOS

The app can be used to check whether a device is BLE capable or not.

### RAMSES BLE app



Settings, device management  
Software info

Selection of OpenTherm  
device

Set temperature, adjustable in  
increments of 0.2 °C (2 °C  
– 30 °C)

Info: External input, flame,  
PIN etc.

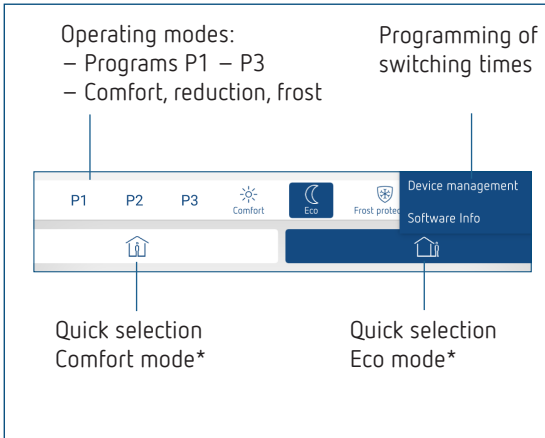

\*until the next switching time

## Connecting clock thermostat and smart-phone (via app) – pairing

The clock thermostats can be programmed using an app (from Android 4.3, iOS 5) on a mobile end device. Communication takes place via Bluetooth BLE.

- Download the RAMSES BLE app from the App Store or Google Play Store



- Open the app
  - Window with offline mode/assign appears
- Press the button on RAMSES BLE OT for 3 s (green LED at RAMSES BLE OT flashes)
- Press **Assign**
  - Device list appears
- Select device and press ok
- Enter the name for RAMSES BLE OT (e.g. living room ...)
- Confirm with ok
  - RAMSES BLE OT is now paired. Each time when restarting the app, a connection will be established. This takes several seconds (the Bluetooth icon on the top left of the app flashes)

### Loading additional devices ...

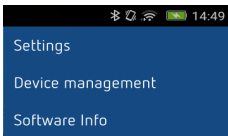

- Press device management
  - A window will open
- Press +
  - Further devices will be searched ...





# Program

In the program menu,

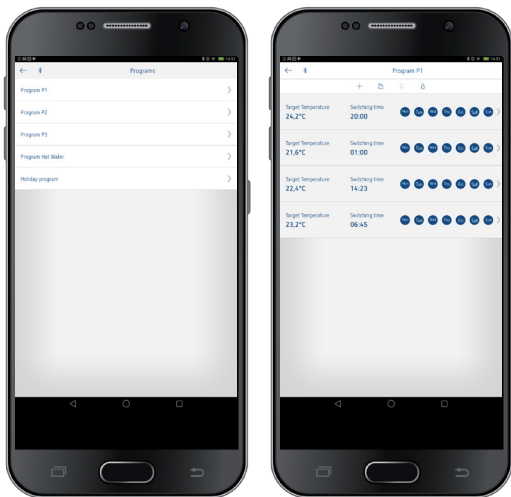
- programs P1 – P3 can be changed
- a new program, or
- a holiday program can be created, or
- a domestic water program, in case of a heating system using domestic water



- Programs P1 – P3 can be set, edited, or deleted.
- A maximum of 24 switching times can be set per program, up to a total of 42.

① During programming, selected days are shown like , and unselected days like .

The created programs are automatically sent to the clock thermostat.

## Creating a holiday program

In order to create a holiday program and activate it,

► slide the controller to "Activation"

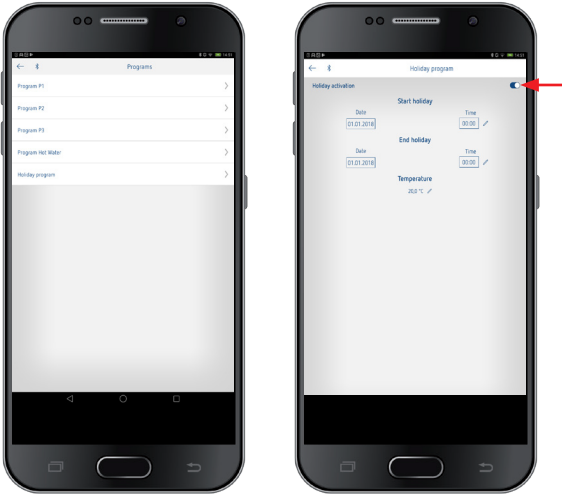

After a holiday program has been created via the app, the clock thermostat receives the following information:

- active/not active
- Start date and end date with time
- Room set temperature during holiday time
- If holiday time is active, the domestic water heating will be switched off (set temperature 10 °C)



# Info

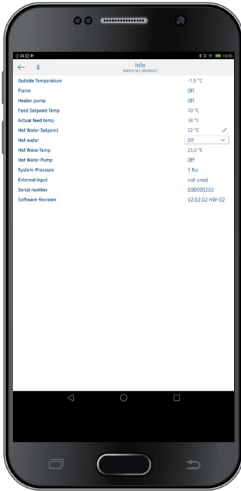

① The information in this submenu vary depending on the connected boiler.

With **Info**, temperature, flame, set flow etc. can be queried. The functions change, depending on the connected heating system.



# Settings

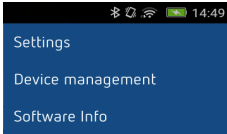

- Press Settings  
→ A window will open

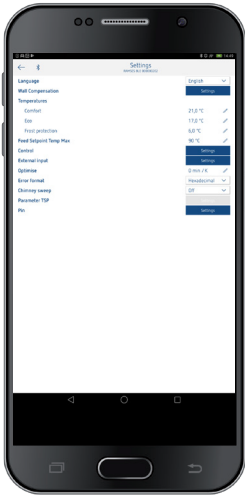

- ① The functions in this submenu have to be set by the qualified electrician.

In the settings, language, temperature (comfort, eco, frost), wall compensation, optimisation, chimney sweep function, etc. can be set.

## 1. Setting the wall compensation

If the installation location is unfavourable, temperature deviations between detected and actual room temperature might occur. This difference can be corrected by using the wall compensation.

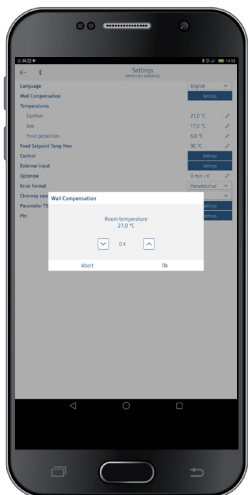

## 2. Setting the controller

The clock thermostat can be used – depending on the set heating – as room-dependent (room temperature dependent) or weather-dependent (outdoor temperature dependent) version, or as a relay version.



## When connected to a modulating heating



- In the room-dependent version, the room set temperature is used for direct control.

P band (0.5 K–2.5 K)	control range
I share (1–20)	integral share in minutes:
– Integral share small →	quick adjustment of the control deviation
– Integral share large →	slow adjustment of the control deviation
- In the weather-dependent controller, the flow temperature is determined by a defined heating curve. The setting of base point and end point always refers to a room set temperature of 21 °C.



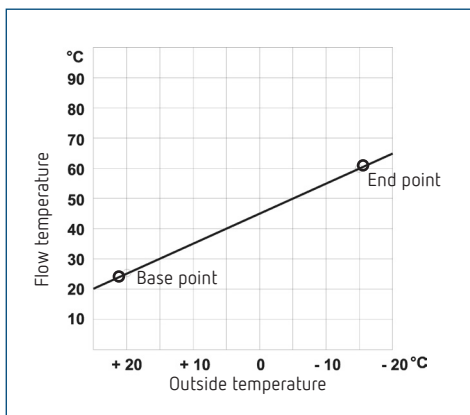

## Setting the heating curve

With weather-dependent control, the base point and end point of the curve can be set.

	Setting range	Factory settings
Base point	10–40 °C	+25 °C
End point	25–90 °C	+60 °C

## Setting parameters for the heating system

Heating type		Flow / return temperature
Radiator heating	High temperature	90 / 70
Radiator heating	Medium temperature	70 / 50
Underfloor heating	Lowest temperature	40 / 30

Heating type	HVAC base point	HVAC end point	P -adjustment/ reduction	Frost line
90 / 70 system	30 °C	85 °C	15 °C	3 °C
70 / 50 system	25 °C	75 °C	15 °C	3 °C
40 / 30 system	25 °C	45 °C	15 °C	3 °C

## Changing the heating curve temporarily

In case of an offset of the desired room set temperature, a corresponding offset for the flow set temperature will be calculated. The set offset determines by which value the flow set temperature will be offset per degree from the room set temperature of 21 °C.

### Example

At an outside temperature of – 5 °C, a flow set temperature of e.g. 50 °C will be calculated for the settings of base point and end point, in order to reach the room set temperature (reference temperature) of 21 °C. However, if the desired room set temperature is at 19 °C, at a set offset of 10 K/°C, a flow set temperature of

**flow set temperature = 50 °C – (21 °C – 19 °C) x 10 K/°C = 50 °C – 20 K = 30 °C** will be calculated.

## Switching off the heating (heating off at)

With weather-dependent control, you can program the controller so that the heating switches off at a set outdoor temperature.



## Setting the room influence

With weather-dependent control, the flow temperature can be adjusted if there is a large divergence between the room temperature and the set temperature.

Offset feed temperature	= $\Delta T_v$
Set room influence	= PI
Setpoint value of room temperature	= $T_{R\ set}$
Actual value of room temperature	= $T_{R\ act}$
$\Delta T_v$	= PI ( $T_{R\ set} - T_{R\ act}$ )
Example: $T_{R\ set} = 20\ ^\circ\text{C}$	$T_{R\ act} = 18\ ^\circ\text{C}$ PI = 3
$\Delta T_v$	= $3 \times (20\ ^\circ\text{C} - 18\ ^\circ\text{C}) = 6\ \text{K}$

→ The flow temperature is increased by 6 K.

The higher the selected room influence, the greater the influence of the room temperature on the flow temperature.

## Connection of an OpenTherm Control Box with relay output

### Behaviour of a PD controller (pulse duration controller)

With adapted heating systems, a PD controller is characterised by its short transient time, minimal overshoot and high control accuracy.

### Behaviour of a hysteresis (on/off) controller

In over or undersized heating systems, a hysteresis controller is characterised by a minimum switching frequency and low temperature deviations.



### 3. External input

The external input can be configured for various external sensors.

 Input is active, therefore do not use external voltage. The connected contact must be floating and electrically isolated.

#### The following options are available with the individual sensors/contacts

Floor	Temperature limit	Floor temperature restriction, floor temperature selection adjustable between 20 °C and 50 °C; floor sensor (9070321)  ⓘ no safety temperature limiter, but device type 1 in accordance with EN 60730-1
Room temperature	no options	The internal temperature sensor will be switched off; external temperature sensor (IP 65) (9070459)
Presence detector	Temperature selection	This temperature is used for control if the HVAC output of the presence detector is switched. If no presence is detected, the set program is used for control
Window contact	no options	As long as the window contact is switched, the thermostat controls to frost protection temperature
Telephone contact	Temperature selection	Select temperature for the controller if the telephone contact is switched

#### Error display at RAMSES BLE OT

ⓘ If the external input is set to "floor" or "room temperature", an appropriate temperature sensor has to be connected. If this sensor is missing, the red LED flashes at one second intervals.



## 4. Setting the optimisation

The optimisation function allows you to achieve a certain room temperature at a desired switching point. The display shows how many minutes earlier the heating starts. This time applies per K of temperature difference between actual temperature and desired set temperature.

### Example

At 06.00 a.m. in the morning, a change in the bathroom is programmed from reduction (17 °C) to comfort temperature (23 °C).

Without optimisation function, the room thermostat enables the heating request for the bathroom at 06.00 a.m. Depending on the size of the room and the installed heating system, the bathroom reaches the desired 23 °C at 6.30 a.m., for example.

With a set optimisation of 5 min/K, the thermostat sends the heating request earlier, as follows:

Set temperature at 06.00 a.m. → 23 °C  
Actual temperature → 17 °C  
i.e. Delta T = 6 K  
 $6 \text{ K} * 5 \text{ min/K} = 30 \text{ min}$

The controller sends the heating start 30 min. earlier and reaches the setpoint temperature at 06.00 a.m.

- ① The optimisation value depends on the spatial and heating conditions.

## 5. Setting the error format

Error notifications from OpenTherm heaters can be received, depending on the manufacturer, in a hexadecimal or decimal format (see instructions for the OpenTherm heater).

## 6. Setting the chimney sweep function

This function is used to carry out the legally required emission measurements (off, partial load, full load). It is automatically switched off after 30 min.

## 7. Setting TSP parameters (Transparent Slave Parameters)

Depending on the connected OpenTherm heater, various TSP parameters can be set (see instructions for OpenTherm heater).





## 8. PIN

This function can be used to assign a new PIN.

- The factory setting for the PIN is 0.
- New PIN can be entered (1 – 6 digits).
- In case of **Delete pairing** (2nd pairing), the PIN is set to 0.
- If the PIN is 0, the PIN will not be requested during pairing.



## 7. Technical data

Supply voltage:	OT bus (approx. 50 mW)
Controller type:	modulating controller, works with OpenTherm protocol (OpenTherm V4.0 with SmartPower)
Temperature setting range:	+ 2 °C ... + 30 °C in increments of 0.2 °C
Memory locations:	42
Protection rating:	IP 20 in accordance with EN 60529
Protection class:	III in accordance with EN 60730-1
Operating temperature:	+ 0 °C ... + 50 °C
Power reserve:	4 hours
Mode of operation:	Type 1 STU in accordance with EN 60730-1
Rated impulse voltage:	0.33 kV
Pollution degree:	2
Software	Class A

## 8. Contact

Theben AG  
Hohenbergstr. 32  
72401 Haigerloch  
GERMANY  
Phone +49 7474 692-0  
Fax +49 7474 692-150

### Hotline

Phone +49 7474 692-369  
hotline@theben.de

**Addresses, telephone numbers etc.**  
**www.theben.de**