

thePassa P360 KNX UP WH
2019300
thePassa P360 KNX UP GR
2019301
thePassa P360 KNX UP SF
2019303



1. Product characteristics

- Passive infrared presence detector for ceiling installation
- Rectangular detection area of 360°, up to 30 m x 5 m (150 m²)
- 2 separate detection zones
- Restriction of detection area with cover clips
- Automatic presence- and brightness-dependent control for lighting and HVAC
- Mixed light measurement suitable for fluorescent lamps (FL/PL/ESL), halogen/incandescent lamps and LEDs
- 2 directed light measurements
- 2 channels C1, C2 light with two light measurements
- Switching or constant lighting control with 2 independent control systems and standby function (orientation light)
- Switching mode with dimmable lighting
- Fully or semi-automatic operation, switchable
- Brightness switching value or setpoint value can be set in lux by using parameters, the object or via remote control
- Teach-in of the brightness switching value or the setpoint value
- Self-learning light time delay can be set via parameters, object or remote control
- Reduction of light time delay when present briefly (short-term presence)
- Walking direction recognition by means of telegrams
- Aura effect can be implemented
- Manual override by telegram or remote control
- 2 channels C4, C5 presence, individually configurable
- Switch-on delay and presence time delay can be set
- Setting the room correction factor for brightness measurement calibration
- Configurable sensitivity
- Extremely easy configuration of the energy-saving response with the "eco plus" function
- Test mode for checking function and detection area
- Scenes
- Parallel switching of multiple presence detectors (Master/Slave or Master/Master)
- Ceiling installation in flush-mounted box
- Surface mounting on ceilings possible with back box (option)
- User remote control "theSenda S" (option)
- Management remote control "SendoPro" (option)
- Installation remote control "theSenda P" (option)

- App remote control "theSenda B" (option) and corresponding app "theSenda Plug" (iOS/Android)

2. Safety



Make yourself familiar with the presence detector, prior to installation and start-up. To do so, read this operating manual and the "KNX manual thePassa P360".

- Work on electrical systems may only be carried out by qualified electricians or by instructed persons under the guidance and supervision of a qualified electrician in accordance with the technical regulations applying to electricity!
- Comply with the country-specific safety regulations for work on electrical systems!
- The device is maintenance-free. If the device is opened or penetrated with any object, the guarantee lapses.

3. Proper use

The presence detector is intended for indoor installation. The presence detector is exclusively intended for the use as contractually agreed between the manufacturer and the user. Any other use is considered to be unacceptable. The manufacturer does not accept liability for any resulting damages.

4. Function

The presence detector is primarily used in passage areas, staircases, garages, basements and warehouses for convenient and energy-efficient control of lighting as well as HVAC. The lighting is accordingly influenced by switching or constant lighting control.

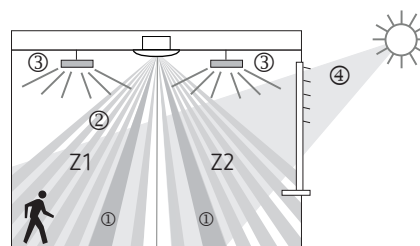

- ① Mixed light measurement
- ② Presence detection
- ③ Artificial light
- ④ Incident daylight

Channel C1, C2 light

The presence detector detects people present based on smallest movements. Its 2 light sensors simultaneously measure the brightness in the room and can thus steplessly control the lighting or switch it on and off according to the daylight. The light outputs can be dynamically faded up and down by the integrator. The brightness switching value or setpoint value is adjusted by means of a parameter, object or the remote control.

Switching

The lighting switches on with presence and insufficient brightness, and off with absence or sufficient brightness. Manual switching or dimming can be performed with a button. Manual switching off, dimming and scenes stop the control for the duration of the presence.

Constant lighting control

When constant lighting control is active, the brightness is held constant at the brightness setpoint value. The control is started fully automatically or manually via push button or remote control. Manual switching off, dimming and scenes stop control for as long as the presence continues.

Time delay

The minimum time delay can be set for all light channels in the range of 30 seconds to 60 minutes. It adjusts automatically to the user's behaviour and can increase independently to 30 min or reduce back to the set minimum time. With settings ≤ 2 min or ≥ 30 min, the time delay remains unchanged at the set value. If someone goes into an unoccupied room only briefly and leaves it within 30 seconds, then the light will be switched off prematurely after 2 minutes (short-term presence).

Standby

The standby function acts as an orientation light. After the time delay expires, the lighting is set to the standby dimming value (1 - 25%). The standby time can be set between 30 s and 60 min, or permanently. The lighting switches off if the brightness level in the room exceeds the brightness switching value / setpoint value. The lighting switches to the standby dimming value independently if the room brightness falls below the brightness switching value / setpoint value. The standby function can be activated or blocked via an object. In conjunction with a time switch, this allows energy-saving solutions to be implemented.

Button control

The lighting can be manually switched or dimmed any time via a button. If the light is switched on manually, the light will remain on during switching operation for at least 30 minutes, provided people are present. It then switches off if there is enough brightness. The light is forced off after a preset time delay if the room was (previously) vacated. If artificial lighting is switched off manually, the lighting remains switched off as long as the room is occupied. The lighting switches again automatically after the time delay has expired.

Fully or semi-automatic device

Lighting control via the presence detector operates fully automatically for increased comfort or semi-automatically for greater energy savings. As a "fully automatic device", the lighting is switched on and off automatically. As a "semi-automatic

device", the lighting must always be switched on manually. The lighting is switched off automatically.

Exceptionally easy configuration of the energy-saving behaviour

By using the selection "eco" for optimal switching behaviour or "eco plus" for maximum energy savings, users can adjust the presence detector to their needs in an extremely easy manner.

Walking direction recognition

For presence in zone 1 or zone 2, an ON telegram will be sent in each case. After leaving the zone, an OFF telegram is sent. Proper evaluation allows a walking direction recognition.

Aura effect

With the aura effect function, the light follows the users based on the area they are in. The surrounding areas are dimmed up to a set orientation light value. This guarantees better orientation and greater safety.

Channel C4, C5 presence

The presence channels are typically used for HVAC control. According to the selection, a telegram will only be sent in case of presence, completely independently of the brightness and after expiry of the switch-on delay. With every motion, the time delay will be restarted. Buttons do not influence the presence channel.

Switch-on delay

The switch-on delay prevents instantaneous switching on. The telegram is sent only on expiry of the switch-on delay, provided that people are present at this time.

Time delay

The time delay enables delayed switching off of HVAC devices and systems after the room is vacated. If selected, a telegram can be sent after the expiry of the presence time delay (once or cyclical).

5. Detection area

The rectangular detection area of the Passa presence detector covers a large detection area, and permits a complete coverage of the corridor. The detection area is divided into two zones. It is possible that, in certain areas, the detection area is larger than stated. The recommended installation height is 2.0 m – 6.0 m. As installation height increases, the sensitivity of the presence detector decreases. This sensitivity can be adjusted in 5 levels via a parameter or the remote control.

From installation heights of 3.5 m, the detection areas of several detectors should overlap in the marginal zones. The detection range is reduced as the temperature increases.

Detection areas zone 1 and zone 2

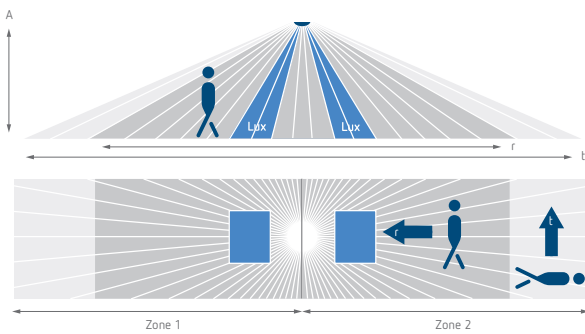

Installation height (A)	walking persons frontal (r)	walking persons across (t)
2.0 m	16 x 3.5 m (56 m ²)	16 x 3.5 m (56 m ²)
2.5 m	18 x 4 m (72 m ²)	22 x 4 m (88 m ²)
3.0 m	20 x 4.5 m (90 m ²)	30 x 4.5 m (135 m ²)
3.5 m	20 x 5 m (100 m ²)	30 x 5 m (150 m ²)
4.0 m	20 x 5 m (100 m ²)	30 x 5 m (150 m ²)
4.5 m	20 x 5 m (100 m ²)	30 x 5 m (150 m ²)
5.0 m	20 x 5 m (100 m ²)	30 x 5 m (150 m ²)
5.5 m	20 x 5 m (100 m ²)	30 x 5 m (150 m ²)
6.0 m	20 x 5 m (100 m ²)	30 x 5 m (150 m ²)

All figures are guidance values.

Detection area zone 1 or zone 2

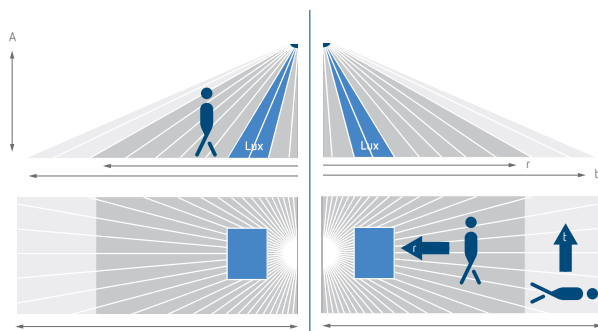

Installation height (A)	walking persons frontal (r)	walking persons across (t)
2.0 m	8 x 3.5 m (28 m ²)	8 x 3.5 m (28 m ²)
2.5 m	9 x 4 m (36 m ²)	11 x 4 m (44 m ²)
3.0 m	10 x 4.5 m (45 m ²)	15 x 4.5 m (68 m ²)
3.5 m	10 x 5 m (50 m ²)	15 x 5 m (75 m ²)
4.0 m	10 x 5 m (50 m ²)	15 x 5 m (75 m ²)
4.5 m	10 x 5 m (50 m ²)	15 x 5 m (75 m ²)
5.0 m	10 x 5 m (50 m ²)	15 x 5 m (75 m ²)
5.5 m	10 x 5 m (50 m ²)	15 x 5 m (75 m ²)
6.0 m	10 x 5 m (50 m ²)	15 x 5 m (75 m ²)

All figures are guidance values.

Brightness measurement

The presence detector measures artificial light and daylight by means of two directed light measurements. Light measurement Z1 measures the brightness in zone 1. In zone 2, light measurement Z2 measures the brightness. The alignment of both brightness measurements has to be taken into account during installation. The installation location is the reference point for the lighting level. The brightness measurement can be adapted to the conditions in a room with the room correction factor.

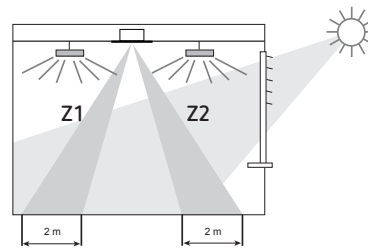

Each light measurement zone maps a rectangle of about 2 x 4 m on the floor. Depending on the selected the detection zone, the light measurements are assigned as follows:

Selection of detection zone	Lighting channel	Light measuring zone
only zone 1	Channel C1 - light	Zone 1
only zone 2	Channel C2 - light	Zone 2
Zone 1 + zone 2 together	Channel C1 - light	∅ from zone 1 + zone 2
Zone 1 / zone 2 separately	Channel C1 - light/ channel C2 - light	Zone 1 / zone 2

Direct light influences the light measurement. Avoid placing floor lamps or suspended lighting directly below the detector.

Constant lighting control

The detector must be positioned in such a way that it only detects artificial light that it controls itself. Artificial light that is controlled by other detectors or manually switched work lighting influence the brightness measurement of the detector. The detector must not be exposed to direct artificial light.

Switching mode

If the brightness measurement is deactivated, the light only comes on when presence is detected (brightness setpoint value set to "measurement off" via the remote control).

Suitable lamps

The presence detector is designed for the operation of fluorescent, compact fluorescent, halogen and incandescent lamps as well as LEDs.

6. Installation

Flush-mounted fitting

The presence detector is flush-mounted using a size 1 standard flush-mounting installation socket.

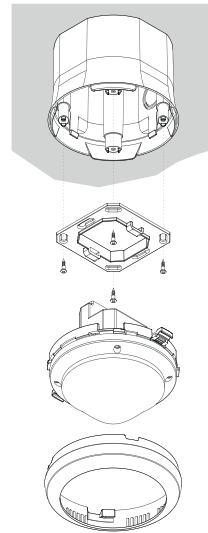
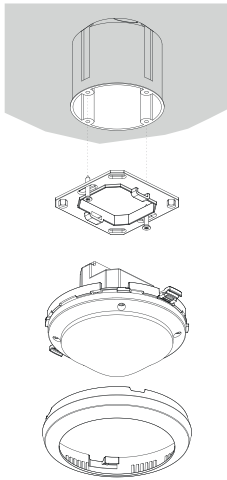

Ceiling installation

A ceiling installation unit 73 A is available for simplified ceiling installation of the presence detector (see accessories). This also ensures cord grip and contact protection. The installation diameter is 72 mm (drill diameter 73 mm).

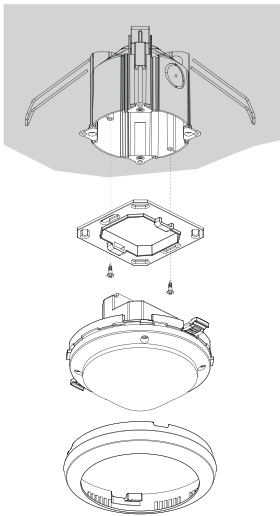

Surface-mounted installation

A back box 110A is available for surface mounted installation (see accessories).

7. Start-up

1. Settings

All settings are made via ETS. See document "KNX manual thePassa" (application description). Management remote control "SendoPro 868-A", service remote control "theSenda P", and app remote control "theSenda B" (with "theSenda Plug" app) are optionally available for support during start-up. The "SendoPro 868-A" and "theSenda B" (with "theSenda Plug" app) can be used to query, adjust and optimise parameters. Parameters can only be adjusted with the "theSenda P". In this sense, the remote controls serve as set-up aids. A range of variable parameters is available for adjustment via the remote control (see chapter "Parameters via remote control"). The response during operation can be changed via the remote control's control commands.

2. Programming mode

The programming mode can be activated either by means of the programming button on the back of the presence detector or, without removing the presence detector, by means of the "SendoPro 868-A" management remote control, "theSenda P" installation remote control, or "theSenda B" app remote control (with "theSenda Plug" app).

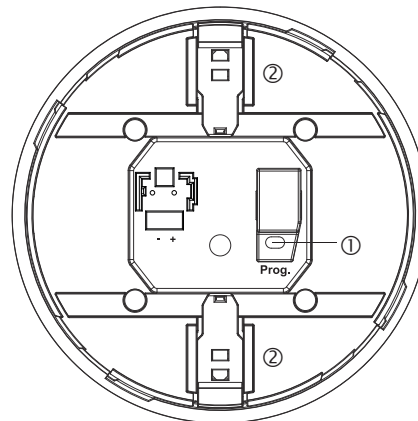

- ① Programming mode button
- ② Mechanical safety lock

3. Restore device factory settings

The presence detector is supplied with a factory setting. This factory setting can be restored.

Activation	Description
Power up	Hold down the programming button while switching on the bus voltage.

4. Operation mode

The thePassa P360 KNX knows 3 operating modes

- Normal
- test presence
- test light

5. Switch-on behaviour

After the bus voltage is switched on or the parameters are downloaded via the ETS, the detector first runs through the start-up phase of 30 s, then it changes into normal operation. An LED displays the current status.

1. Start-up phase (30 s)

- The LED flashes at one second intervals.
- Switching: Light outputs send an ON telegram regardless of brightness.
- Constant lighting control: control inactive, the lighting will be dimmed up to the maximum (value telegram max. control value).
- When no one is present or there is sufficient brightness, an OFF telegram is sent after 30 s (light off).

2. Operation mode normal

- The detector is ready for operation (LED off).

3. In the event of malfunction

- LED flashes rapidly
- For troubleshooting, see the chapter "Troubleshooting"

8. Parameters via remote control

The following parameters can be queried or changed via the remote control for support during installation as well as servicing:

Parameter	Description	Can be queried by Sen-doPro/ the-Senda B (app)	Can be changed by Sen-doPro/ the-Senda B (app)	Can be changed by the-Senda P
Brightness setpoint value C1	Value range in lux	x	x	x
Alternative brightness set point value C1	Value range in lux	x	x	
Brightness measurement value C1	Lux meter brightness value in lux		x	
Brightness actual value C1	Measured brightness value in lux	x		
Brightness setpoint value C2	Value range in lux	x	x	x
Alternative brightness set point value C2	Value range in lux	x	x	
Brightness measurement value C2	Lux meter brightness value in lux		x	
Brightness actual value C2	Measured brightness value in lux	x		
Light time delay	Value ranges in seconds/ minutes		x	x
Detection sensitivity (PIR)	Value range in increments	x	x	x

With the "SendoPro 868-A" management remote control, as well as with "theSenda B" app remote control (with "theSenda Plug" app), parameters can be queried by sending values level-by-level to the detector. If the sent value is below the set parameter, the LED illuminates briefly. If the sent value is equal to or above the set parameter, the LED flickers for 2 seconds.

This adjustment of parameters does not change the settings in ETS.

Alterable parameters via remote control

1. Adjustment with the remote control

The parameters are sent to the presence detector via infrared by using the "SendoPro 868-A" management remote control, the "theSenda P" service remote control, or "theSenda B" app remote control (with "theSenda Plug" app). Changed parameters will be immediately accepted and applied by the detector.

LED description

Flickering for 2 s

After sending the new parameter with remote control or app, the presence detector indicates the correct reception by flickering for 2 s.

Lighting up briefly

The parameter/command sent from the remote control was rejected by the presence detector. The command is not valid. Check the selected detector type and sent parameters with management remote control or app remote control (app).

2. Brightness switching value / setpoint value channel C1, C2 light

The brightness switching value / setpoint value defines the minimum desired brightness. The currently prevailing brightness is measured underneath the presence detector. If the prevailing brightness is below the switching value/setpoint value, the light is switched on when a presence is detected (in configuration type fully automatic device).

Value range

Adjustable values "SendoPro 868-A" / "theSenda B" (app)	10–3000 lux
Adjustable values "theSenda P"	10, 15, 300, 500, 800 lux
Deactivation of brightness measurement (brightness measurement has no effect) The light channels only switch according to presence and absence.	
"SendoPro 868-A" / "theSenda B" (app)	Measurement off
"theSenda P"	Button ☀

3. Alternative brightness switching value / setpoint value channel C1, C2 light

The alternative brightness switching value / setpoint value can be used to define a second different brightness switching / setpoint value. For example, a day and night mode with two different brightness levels can be set up in combination with the brightness switching value / setpoint value channel C1 and C2 light. The alternative brightness switching value / setpoint value is activated or switched via bus object.

Value range

cf. 2nd brightness switching value / setpoint value channel C1, C2 light

4. Brightness measurement value C1, C2

The brightness measurement value at the ceiling is influenced by the installation location, incidence of light, position of the sun, weather conditions, the reflection properties of the room, and the furniture. In order to be able to adhere to the required lux value in the desired area, a comparison of the brightness measurements as necessary.

When sending the brightness measurement value, the room correction factor of the corresponding lighting channel is automatically adjusted to the conditions inside the room. The measured lux value ① below the presence detector is sent to the detector by the remote control. Two different procedures can be selected for the comparison.

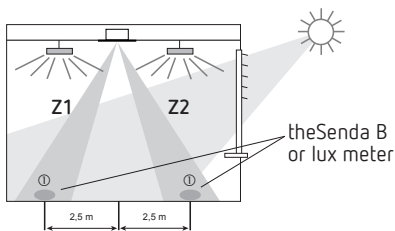

$$\text{Room correction factor} = \frac{\text{Brightness value at the ceiling}}{\text{Brightness value on the floor}}$$

- ① Please note the instructions in the "KNX thePassa" manual concerning the calibration of light measurements or setting the room correction factor.

Using management "SendoPro 868-A" remote control and lux meter:

- Dim all lights to maximum power. If possible, move down the blinds.
 - The lux meter is placed on the work surface below the sensor and the measured lux value is entered via the management remote control "SendoPro 868-A", parameter <brightness measurement value C1, C2>.
- During lux measurements, observe the distances shown in the diagram. Carry out all measurements on the floor.
- Using zone 1 only: Place lux meter during the brightness measurement in zone 1 (approx. 2.5 m away from the detector).
- Using zone 2 only: Place lux meter during the brightness measurement in zone 2 (approx. 2.5 m away from the detector).
- Using zone 1 +2: Place lux meter in the middle.
- Using zone 1 +2 separately: Place lux meter for C1 during the brightness measurement in zone 1. Place lux meter for C2 during the brightness measurement in zone 2.
 - The room correction factor will be calculated automatically. Values between 0.05 and 2.0 are permitted. Calculated or entered values outside the permitted range will automatically be set to the appropriate limit value.
 - The calculated room correction factor will be applied.

Using "theSenda B" remote control and "theSenda Plug" app:

- Connect "theSenda B" remote control with the corresponding "theSenda Plug" app.
- Select the appropriate detector type and load the parameter set.
- Select <Brightness measurement value C1, C2> parameter.

Using theSenda B remote control

- Set up theSenda B according to the drawing, and move away a few steps from the measurement location, so the lux measurement will not be influenced.
- Press OK.
 - A new window with the measured brightness measurement value is shown. If you would like to apply this value,
- Press OK.
- **Important:** Press the send button (☀). After this, the brightness measurement is harmonised.

Using lux meter

- Set up or align the lux meter according to the drawing, and read the lux value.
- Press "Enter" in the app.
 - A new window opens.
- And the lux value and press OK.
 - Brightness measurement value appears in the display.
- **Important:** Press the send button (☀). After this, the brightness measurement is harmonised.

- The room correction factor will be calculated automatically. Values between 0.05 and 2.0 are permitted. Calculated or entered values outside the permitted range will automatically be set to the appropriate limit value.
- The calculated room correction factor will be applied.

For monitoring purposes, the room correction factor can be queried via object 8 for channel C1 and via object 19 for channel C2.





The room correction factor can be changed directly only via the ETS. The standard value is 0.3, and is suitable for most applications. Changes are only sensible in widely deviating situations.

5. Light time delay

Value range

Adjustable values "SendoPro 868-A" / "theSenda B" (app)	30 s - 60 min
Adjustable values "theSenda P"	30 s, 60 s, 2 min, 10 min, 20 min, 60 min

6. Detection sensitivity

The detector has 5 sensitivity increments. The basic setting is the middle increment (3). With the "SendoPro 868-A" management remote control, as well as with "theSenda B" app remote control (with "theSenda Plug" app), the increments 1 to 5 can be selected and sent to the detector. With the "theSenda P" installation remote control, the sensitivity can be decreased  or increased  by one increment each time the button is pushed.

Increment	Sensitivity
1	very insensitive
2	insensitive
3	Standard
4	sensitive
5	very sensitive

By selecting the test presence operating mode, the set sensitivity increment is not changed.

9. Control commands via remote control

The following control commands can be triggered with the remote control:

Control command	Description	Can be triggered by SendoPro / theSenda B (app)	Can be triggered by theSenda P
Programming mode	Activation of programming mode	x	x
Teach-in channel C1	Teach-in of brightness setpoint value	x	x
Teach-in channel C2	Teach-in of brightness setpoint value	x	x
Teach-in channel C1 + C2	Teach-in of brightness setpoint value	x	x
Master/Slave query	Master / Slave	x	
Switching light	All lighting groups can be switched on and off.	x	x
Presence test	On/Off	x	x
Light test	On/Off	x	
Restart	Restart detector	x	x

Teach-in

The currently measured brightness value will be accepted as the brightness set point value. Transfer is made to the currently active brightness setpoint value. This means that when switched to the alternative brightness setpoint value, the currently measured brightness value (lux) is transferred to the alternative brightness setpoint value by the teach-in command. Values outside the permitted range will automatically be set to the appropriate limit value.



Test mode

The thePassa P360 KNX has two test modes.

- Presence test
- Light test

1. Presence test

The presence test is used for checking the detection area and the parallel switching.

Activation	Presence test control command "On" with "SendoPro 868-A" management remote control or with "theSenda B" app remote control (with "theSenda Plug" app). On "theSenda P" installation remote control with the button  . ON telegram via bus object (51). The presence test can be activated anytime.
End	With subsequent restart: Presence test control command "Off" with "SendoPro 868-A" management remote control or with "theSenda B" app remote control (with "theSenda Plug" app). On "theSenda P" installation remote control with the button  (reset). OFF telegram via bus object (51) Mains failure and thus power up Automatically according to the time set in the ETS Without restart: Activation of light test with "SendoPro 868-A" management remote control or with "theSenda B" app remote control (with "theSenda Plug" app).

Indication of LED status of channels	Description
--------------------------------------	-------------

On	When movement occurs, the LED is on and channels C1, C2 switch on.
Off	After the movement stops, the LED is off and channels C1, C2 switch after approx. 10 s.

Test response

- Deactivated brightness measurement, light output does not react to brightness
- The detector reacts as in configuration type fully automatic device, even if semi-automatic is set.
- The control type changes to switching if the control type is set to constant lighting control. The light is not controlled.
- Light "On" during motion; light "Off" during absence
- Channels C1 and C2 light have a fixed time delay of 10 s.
- The response of the presence channels remains unchanged as in normal operating mode.

Commands and adjustable parameters

In the presence test, the following commands are possible with "SendoPro 868-A" management remote control and "theSenda B" app remote control (with "theSenda Plug" app):

- End presence test
- Activating the light test
- Changing detection sensitivity



The selected detection sensitivity (1 . . 5) is unchanged on activation of the presence test. Sensitivity can be adjusted during the test.

The presence detector performs a restart after the end of the test mode.

2. Test-light

The light test is used to check the brightness switching value / set point value.

Activation	Presence test control command "On" with "SendoPro 868-A" management remote control or with "theSenda B" app remote control (with "theSenda Plug" app). ON telegram via bus object (52) The light test mode can be activated anytime.
------------	--

End	With subsequent restart: Light test control command "Off" with "SendoPro 868-A" management remote control or with "theSenda B" app remote control (with "theSenda Plug" app). On "theSenda P" installation remote control with the button  (reset). OFF telegram via bus object (52) Mains failure and thus power up Automatically according to the time set with the ETS Without restart: Activation of presence test with "SendoPro 868-A" management remote control, "theSenda B" app remote control (with "theSenda Plug" app), or "theSenda P" installation remote control using the "test" button 
-----	--

LED display	Description
Flashing, 5 s Off 0.3 s On	The LED flashes as long as the light test is active.

Test response

The presence detector responds 100 % as in normal operating mode, only the reaction to bright/dark is faster. This makes it possible to test the brightness threshold and the adaptive response. The control is also faster. All selected functions and parameters remain unchanged.

Commands and adjustable parameters

In the light test mode, the following commands are possible with "SendoPro 868-A" management remote control and "theSenda B" app remote control (with "theSenda Plug" app):

- End light test
- Change brightness switching value / setpoint value channel C1 and C2 light
- Activate presence test

The presence detector performs a restart after the end of the test mode.



Do not use a torch to switch the presence detector. The presence detector will teach in this and thereby distort the adaptive light thresholds and hysteresis values.

In order to simulate this response, the area below the presence detector should be illuminated or the blinds be operated. Reactivate the light test for a new test.

Troubleshooting

Fault	Cause
Light does not switch on or switches off during presence and darkness	Lux value is set too low; detector set on semi-automatic; light was switched off manually via push button or with remote control; person not within detection area; obstruction(s) interrupting detection; time delay set too short.
Light stays on when someone is present despite sufficient brightness	Lux value is set too high; light was recently switched on manually via push button or by remote control (wait 30 min during switching operation); detector is in test mode.
Light does not switch off, or light switches on spontaneously when no one is present	Wait for time delay (self-learning); thermal sources of interference in the detection area: fan heaters, incandescent lamps/halogen spotlights, moving objects (e.g. curtains hanging in an open window).
Error flashing (3x per second)	Self-test error; Invalid parameter values in the detector (see thePassa KNX manual chapter Parameter settings at Download). Device not properly functional!

LED display

LED	Description
Flashing at 1 second intervals	The presence detector is in the start-up phase.
Flickering for 2 s	The command sent from the remote control via infrared was accepted by the presence detector.
Lighting up briefly	The command sent from the remote control via infrared was rejected by the presence detector. The command is not valid. Check the selected detector type or parameters on the SendoPro or in the app.
Error flashing (3x s)	Error flashing; The presence detector has found an error.
Flashing, 5 s Off 0.3 s On	The presence detector is in light test mode.
Lights up or flickers irregularly	The presence detector is in presence test mode or "LED display movement" is activated. The LED indicates the detection of movements.

Dimensions diagrams

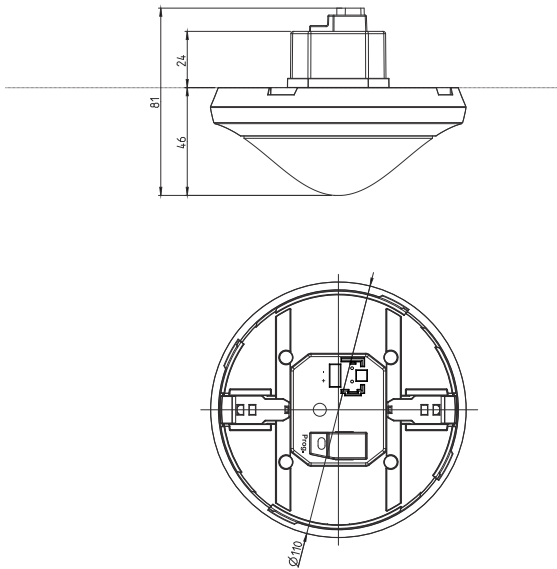

10. Technical data

Operating voltage	Bus voltage KNX, max. 30 V
Power consumption	Approx. 8 mA/9 mA with LED on
Type of installation	Ceiling installation; flush/surface mounted or ceiling installation
Recommended installation height	2.0 – 6 m (minimum height > 1.7 m)
Detection area horizontal	360°
Maximum range	20 x 5 m (Mh. 3.5 m) / 100 m ² radially moving 30 x 5 m (Mh. 3.5 m) / 150 m ² tangentially moving
Setting range of brightness switching value / setpoint value	approx. 10 – 3000 lux / measurement OFF
Light time delay	30 s – 60 min
Presence time delay	10 s – 120 min
Presence switch-on delay	10 s – 30 min / not active
Standby dimming value	1 – 25% of the lamp output
Standby time	30 s – 60 min / not active / permanently on
All settings are remotely configurable	see KNX manual
Connection type	Plug-in terminals, type WAGO 243
Protection rating	IP 20 (IP 54 installed)
Ambient temperature	-15 °C ... +50 °C
CE Declaration of Conformity	This device conforms to the safety regulations of the EMC directive 2014/30/EC.
RCM compliance	This device is compliant with the ACMA guidelines

11. Accessories

Back box 110A WH

Item no.: 9070912

[Details > www.theben.de/en](http://www.theben.de/en)



Back box 110A GR

Item no.: 9070913

[Details > www.theben.de/en](http://www.theben.de/en)



DE (ceiling installation) box 73A

Item no.: 9070917

[Details > www.theben.de/en](http://www.theben.de/en)



Cover clip for area restriction

Item no.: 9070921

[Details > www.theben.de/en](http://www.theben.de/en)



theSenda B

Item no.: 9070985

[Details > www.theben.de/en](http://www.theben.de/en)



theSenda P
Item No.: 9070910
[Details > www.theben.de/en](http://www.theben.de/en)



theSenda S
Item no.: 9070911
[Details > www.theben.de/en](http://www.theben.de/en)



Product overview

Type of installation	Channel	Colour	Type	Item number
Ceiling installation	2 light 2 HVAC	White	thePassa P360 KNX UP WH	2019300
Ceiling installation	2 light 2 HVAC	Grey	thePassa P360 KNX UP GR	2019301
Ceiling installation	2 light 2 HVAC	Special colour in accordance with customer information	thePassa P360 KNX UP SF	2019303

12. Contact

Theben AG
Hohenbergstr. 32
72401 Haigerloch
GERMANY
Phone +49 7474 692-0
Fax +49 7474 692-150

Hotline
Phone +49 7474 692-369
hotline@theben.de
Addresses, telephone numbers etc.
www.theben.de