



- Work on electrical systems may only be carried out by qualified electricians or by instructed persons under the guidance and supervision of a qualified electrician in accordance with the technical regulations applying to electricity!
- Comply with the country-specific safety regulations for work on electrical systems! Ensure absence of voltage in the cable before installation!
- The device is maintenance-free. If the device is opened or penetrated, the guarantee lapses.

1. Product characteristics

- Passive infrared presence detector for ceiling installation
- Rectangular detection area of 360°, up to 30 m x 5 m (150 m²)
- 2 separate detection zones
- Restriction of detection area with cover clips
- Automatic presence- and brightness-dependent control for lighting and HVAC
- Mixed light measurement suitable for fluorescent lamps (FL/PL/ESL), halogen/incandescent lamps and LEDs
- Channel A light: relay, 230 V
- Fully or semi-automatic operation, switchable
- Brightness setpoint adjustable, teach-in function
- Reduction of time delay when present briefly (short-term presence)
- Connection option for push buttons or switches for manual switching with automatic detection of push button/switch
- Staircase light function
- Pulse function for staircase light timer switch
- Channel H, presence: relay, floating e.g. for HVAC control
- Switch-on delay and time delay configurable
- Detection sensitivity configurable
- Ready for immediate use due to factory presetting
- Test mode for checking function and detection area
- Extension of detection area via Master/Slave or Master/Master switching, a maximum of 10 detectors can be switched in parallel with each other
- Ceiling installation in flush-mounted box
- Surface mounting on ceilings possible with back box (option)
- User remote control "theSenda S" (option)
- Management remote control "SendoPro" (option)
- Installation remote control "theSenda P" (option)
- App remote control "theSenda B" (option) and corresponding app "theSenda Plug" (iOS/Android)

3. Proper use

The presence detector is intended for indoor installation. The presence detector is exclusively intended for the use as contractually agreed between the manufacturer and the user. Any other use is considered to be unacceptable. The manufacturer does not accept liability for any resulting damages.

4. Function

The presence detector is primarily used in passage areas, staircases, garages, basements and warehouses for convenient and energy-efficient control of lighting as well as HVAC. The switch contact "light" switches lighting on with presence and insufficient brightness, and off with absence or sufficient brightness. The light can also be switched on/off manually using push buttons or switches.

The "Presence" switch contact controls heating, ventilation and air conditioning systems. The contact closes when someone is present, a switch-on delay permits delayed switch on.

Function description

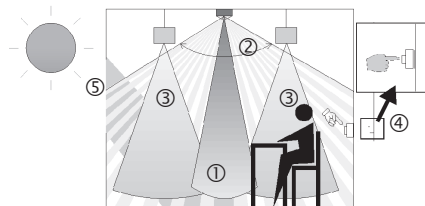

- ① Mixed light measurement
- ② Presence detection
- ③ Artificial light
- ④ Push button for manual lighting control
- ⑤ Incident daylight

2. Safety



WARNING

Danger of death through electric shock or fire!

- Installation should only be carried out by a qualified electrician!

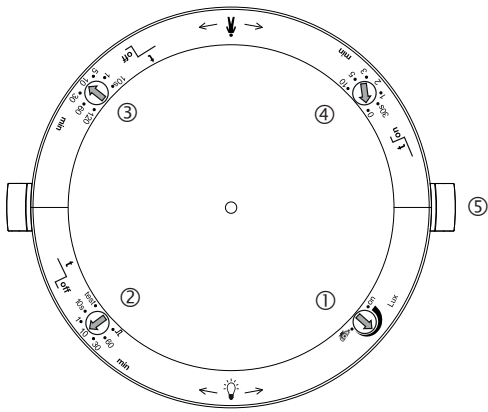

Settings at the Passa P360-101 UP

- ① Brightness setpoint value (lux)
- ② Lighting time delay
- ③ Presence time delay
- ④ Presence switch-on delay
- ⑤ Mechanical safety lock
- ⑥ Mechanical safety lock

Channel A light

Switching response is controlled by presence and brightness. The switch contact closes during darkness and when someone is present. It opens with a delay when there is brightness or when no one is present.

Time delay

The time delay enables delayed switching off of lighting after the room is vacated. The time delay is adjustable in a range of 10 s to 60 min. If someone goes into an unoccupied room only briefly and leaves it within 30 seconds, then the light will be switched off prematurely after 2 minutes (short-term presence).

Push button control

The lighting can be manually switched at any time via a push button or switch. If the light is switched on manually, it will remain on for at least 30 minutes provided that people are present. It then switches off when the brightness is adequate. The light is forced off after the preset time delay if the room was (previously) vacated. If artificial lighting is switched off manually, the lighting remains switched off as long as the room is occupied. The lighting switches again automatically after the time delay has expired.

Fully or semi-automatic device

Lighting control can be fully automatic for increased comfort, or semi-automatic for greater energy savings. The lighting switches on and off automatically as a "fully automatic device". As a "semi-automatic device", the lighting must always be switched on manually. The lighting is always switched off automatically.

Pulse function

Time delay can be set to pulse for controlling existing staircase light timer switches. To do so, the light output produces a pulse of 0.5 s in duration every 10 s if people are present or it is dark.

Channel H presence

Channel H presence is used for HVAC control. The switching response of the floating contact is influenced only by presence and not by brightness. If the contact is closed, the time delay will be restarted at every movement. Push buttons or switches do not influence the contact.

Switch-on delay

The switch-on delay prevents instantaneous switching on. The contact closes only on expiry of the switch-on delay, provided that people are permanently present.

Time delay

The time delay enables delayed switching off of HVAC devices and systems after the room is vacated. The time delay is adjustable in a range of 10 s to 120 min.

5. Detection area

The rectangular detection area of the Passa presence detector covers a large detection area, and permits a complete coverage of the corridor. It is possible that, in certain areas, the detection area is larger than stated. Please bear in mind that, based on the walking direction, the detection area is divided into different sectors. The recommended installation height is 2.0 m – 6.0 m. As installation height increases, the sensitivity of the presence detector decreases.

From installation heights of 3.5 m, the detection areas of several detectors should overlap in the marginal zones. The detection range is reduced as the temperature increases. The detection area is divided into two zones. These can be easily activated or deactivated by using the remote control.

Detection area zone 1 and zone 2 (factory setting)

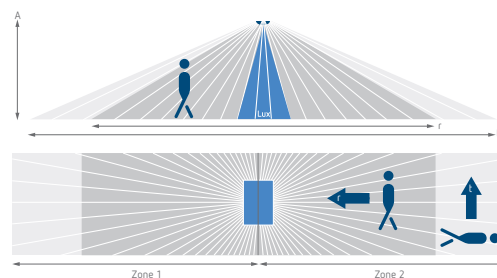

| Installation height (A) | walking persons frontal (r) | walking persons across (t) |
|-------------------------|---------------------------------|----------------------------------|
| 2.0 m | 16 x 3.5 m (56 m ²) | 16 x 3.5 m (56 m ²) |
| 2.5 m | 18 x 4 m (72 m ²) | 22 x 4 m (88 m ²) |
| 3.0 m | 20 x 4.5 m (90 m ²) | 30 x 4.5 m (135 m ²) |
| 3.5 m | 20 x 5 m (100 m ²) | 30 x 5 m (150 m ²) |
| 4.0 m | 20 x 5 m (100 m ²) | 30 x 5 m (150 m ²) |
| 4.5 m | 20 x 5 m (100 m ²) | 30 x 5 m (150 m ²) |
| 5.0 m | 20 x 5 m (100 m ²) | 30 x 5 m (150 m ²) |
| 5.5 m | 20 x 5 m (100 m ²) | 30 x 5 m (150 m ²) |
| 6.0 m | 20 x 5 m (100 m ²) | 30 x 5 m (150 m ²) |

All figures are guidance values.

Detection area zone 1 or zone 2

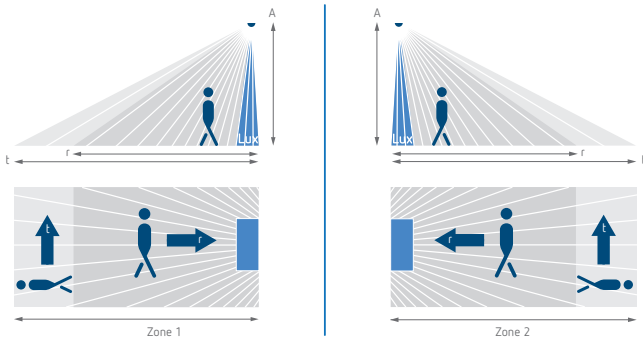

| Installation height (A) | walking persons frontal (r) | walking persons across (t) |
|-------------------------|---------------------------------|---------------------------------|
| 2.0 m | 8 x 3.5 m (28 m ²) | 8 x 3.5 m (28 m ²) |
| 2.5 m | 9 x 4 m (36 m ²) | 11 x 4 m (44 m ²) |
| 3.0 m | 10 x 4.5 m (45 m ²) | 15 x 4.5 m (68 m ²) |
| 3.5 m | 10 x 5 m (50 m ²) | 15 x 5 m (75 m ²) |
| 4.0 m | 10 x 5 m (50 m ²) | 15 x 5 m (75 m ²) |
| 4.5 m | 10 x 5 m (50 m ²) | 15 x 5 m (75 m ²) |
| 5.0 m | 10 x 5 m (50 m ²) | 15 x 5 m (75 m ²) |
| 5.5 m | 10 x 5 m (50 m ²) | 15 x 5 m (75 m ²) |
| 6.0 m | 10 x 5 m (50 m ²) | 15 x 5 m (75 m ²) |

All figures are guidance values.

Brightness measurement

The presence detector measures artificial light and daylight that is reflected below the detector. The light measurement area maps a rectangle of about 1.8 x 3 m at table height. The installation location is the reference point for the lighting level. Direct light influences the light measurement. Avoid placing floor lamps or suspended lighting directly below the detector. If the brightness measurement is deactivated, channel A light only switches depending on presence (brightness setpoint value set to "on" via potentiometer, or set to "measurement off" via remote control).

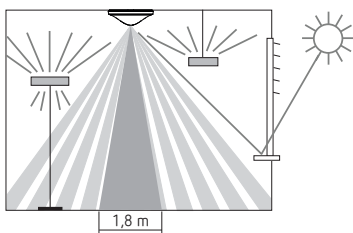

Suitable lamps

The presence detector is designed for the operation of fluorescent, compact fluorescent, halogen and incandescent lamps as well as LEDs. The maximum number of switchable lights is restricted due to the high inrush current levels of the EBs and LED drivers. The use of an external contactor helps with large loads. Parallel switching enables allocation of load to several Masters. All switched loads must be properly suppressed.

6. Installation

Flush-mounted fitting

The presence detector is flush-mounted using a size 1 standard flush-mounting installation socket.

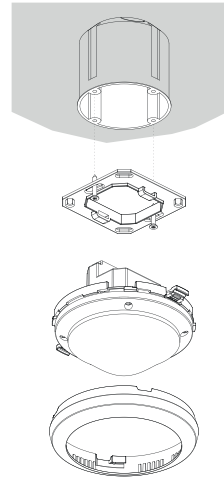

Ceiling installation

A ceiling installation unit 73A is available for simplified ceiling installation of the presence detector (see accessories). This also ensures cord grip and contact protection. The installation diameter is 72 mm (drill diameter 73 mm).

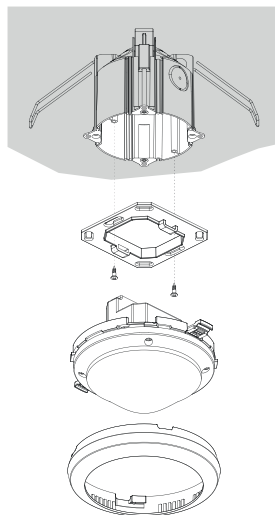

Surface-mounted installation

A back box 110A is available for surface mounted installation (see accessories).

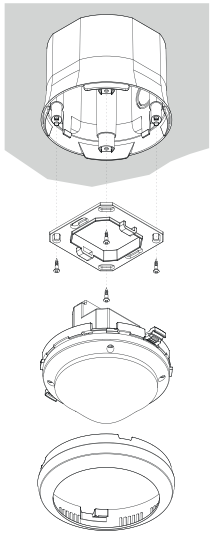

7. Switching

The presence detectors can be combined as Master and Slave: Master in individual switching, Master in parallel switching, Master-Slave parallel switching.

Several push buttons can be connected to one control input. Illuminated push buttons can only be used with neutral conductor connection.

Individual switching

In individual switching, the presence detector, as Master, detects presence and brightness and controls lighting.

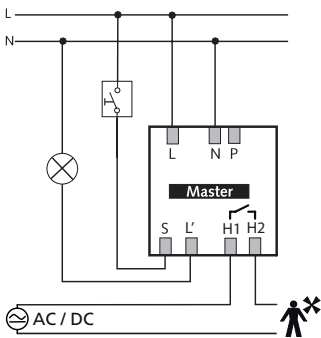

Master/Slave parallel switching

If the detection area covered by one presence detector is insufficient (larger rooms), then up to 10 detectors can be operated in parallel by connecting the P terminals. In the process, presence detection is performed by all detectors together. The Master measures the brightness, operates the buttons and controls the lighting. Slaves are used as further detectors. They only provide presence information.

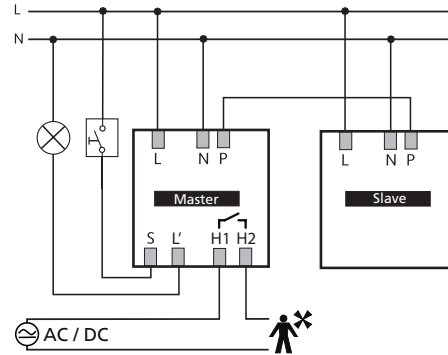

- Light measurement only with the Master
- Parameters are only set on the Master
- Switch up to 10 detectors in parallel
- Use the phase with the same phase for all detectors.

Master: thePassa P360 -101 UP

Slave: thePassa P360 Slave UP

Master/Master parallel switching (for several lighting groups)

Several Masters can be used in a parallel switching. Each Master controls its lighting group according to its own brightness measurements. Delay times and brightness setpoint values are set individually on each Master. Presence continues to be detected by all detectors.

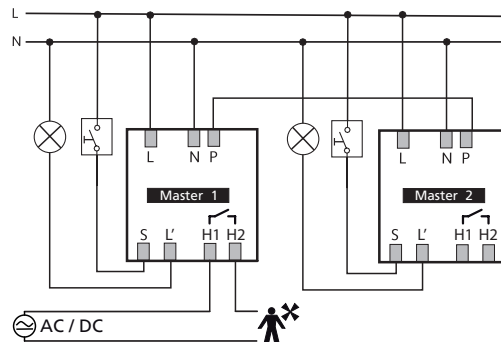

- One Master with individual brightness measurement per lighting group.
- Set potentiometer individually for each Master.
- Switch up to 10 detectors in parallel.
- Use the phase with the same phase for all detectors.
- The presence switch contact can be read by any Master.

8. Settings

The presence detectors are supplied with basic settings ready for operation. The specifications are guidance values. Management remote control "SendoPro 868-A", service remote control "theSenda P" and app remote control "theSenda B" (with "theSenda Plug" app) are optionally available for start-up.

They allow the remote adjustment of the setting values.

Setting of switch contact A light

Potentiometer - Brightness set point value "lux"

The desired brightness setpoint value can be set via the lux potentiometer. The setting range is about 30 to 1000 lux. The factory presetting is 300 lux.

Brightness setpoint values from 30 to 3000 lux can be set via management remote control and app remote control.



Teach-in : When the lux potentiometer is moved to the teach-in position, the LED starts flashing for 20 seconds. As soon as the LED stops flashing, the currently measured brightness value is accepted as the new brightness setpoint value. When the teach-in position is quit, the set value on the LUX potentiometer is accepted as the new brightness setpoint value.

Teach-in can also be carried out using the remote controls "SendoPro 868-A", "theSenda P", or "theSenda B" (with "theSenda Plug app). In this case, the currently measured brightness value is immediately accepted as the new brightness setpoint value.

The brightness measurement is deactivated at potentiometer setting "on". The light channel then switches only depending on presence.

Potentiometer - Lighting time delay

The following guidance values have proved themselves in practice and are recommended as settings:

- Transit zones (no work area) approx. 5 min
- Classroom approx. 10 min
- Work areas (office, meeting room) approx. 10 min
-  "Pulse": Control of staircase light timer switch (0.5 s "on" / 10 s "off")

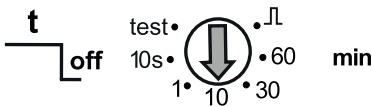

Settings of switch contact H presence

Potentiometer - Presence time delay

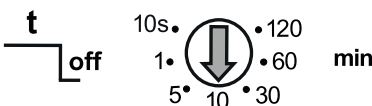

The contact closes if people are present and opens when the room is vacated after the time delay expires.

Potentiometer - Presence switch-on delay



- The contact only closes when someone is present after expiry of the switch-on delay
- 0 = contact closes immediately if people are present

Parameters and control commands via remote control

The following parameters can be checked or changed via the remote control for support during start-up as well as servicing:

| Parameter | Description | Can be queried by SendoPro 868-A / theSenda B (app) | Can be changed by SendoPro 868-A / theSenda B (app) | Can be changed by theSenda P |
|--------------------------------|---|---|---|------------------------------|
| Detection zone | Zone 1 / zone 2 | x | x | |
| Brightness set-point value A | Value range in lux | x | x | x |
| | Measurement off | x | x | x |
| Brightness actual value A | Query brightness actual value | x | | |
| Room correction factor A | Room correction factor | x | x | |
| Brightness measurement value A | Lux meter brightness value in lux | | x | |
| Detection sensitivity | Detection sensitivity (PIR) | x | x | x |
| Time delay A | Value ranges in seconds / minutes | | x | x |
| | Pulse | | x | x |
| Short presence A | On / Off | | x | |
| Time delay H | Value ranges in seconds / minutes | | x | x |
| Switch-on delay H | Value ranges in seconds / minutes | | x | |
| Configuration type | auto / man | x | x | x |
| Control input S | auto / switch / push button S / push button O | | x | |
| Staircase light function | Off / On | x | x | |
| Group address | All / I / II / III | | x | x |
| LED display motion | Off / On | | x | |

The parameters are sent to the presence detector via infrared by using the "SendoPro 868-A" management remote control, the "theSenda P" service remote control, or "theSenda B" app remote control (with "theSenda Plug" app). Changed parameters are immediately applied and used by the detector.

With the "SendoPro 868-A" management remote control, as well as with "theSenda B" app remote control (with "theSenda Plug" app), parameters can be queried by sending values level-by-level to the detector. If the sent value is below the set parameter, the LED illuminates briefly. If the sent value is equal to or above the set parameter, the LED flickers for 2 seconds.

The following control commands can be triggered with the remote control:

| Control command | Description | Can be triggered by SendoPro 868-A/ theSenda B (app) | Can be triggered by theSenda P |
|--------------------|---|--|--------------------------------|
| Teach-in channel A | Activation | x | x |
| Switching light | Lighting group can be switched on and off. | x | x |
| Presence test | On/Off | x | x |
| Restart | Restart detector | x | x |
| Factory settings | Set all parameters and settings to factory setting. | x | |

Detection zone

The detection area is divided into two independent detection zones (see 5. Detection area). For a maximum range, zone 1 and zone 2 are activated. If a limitation of the detection area is required, zone 1 or zone 2 can be deactivated.

Value range

| | |
|---|-------------------|
| Adjustable values "SendoPro 868-A" / "theSenda B" (app) | Z1, Z2, Z1 and Z2 |
|---|-------------------|

Brightness setpoint channel A light

Brightness setpoint A defines the minimum desired brightness. The currently prevailing brightness is measured underneath the presence detector. If the prevailing brightness is below the setpoint value, the light is switched on when a presence is detected (in configuration type fully automatic device).

Value range

| | |
|---|-----------------------|
| Adjustable values "SendoPro 868-A" / "theSenda B" (app) | 30–3000 lux |
| Adjustable values "theSenda P" | 30, 300, 500, 800 lux |

| | |
|--|-----------------|
| Deactivation of brightness measurement (brightness measurement has no effect) The light channels only switch according to presence and absence. | |
| "SendoPro 868-A" / "theSenda B" (app) | Measurement off |
| "theSenda P" | Button ☀ |

Teach-in channel A light

During teach-in, the currently measured brightness value is accepted as brightness setpoint value A. Values outside the permitted range will automatically be set to the appropriate limit value.

| | |
|---------------------------------------|----------|
| "SendoPro 868-A" / "theSenda B" (app) | Teach-in |
| "theSenda P" | Button 👁 |

Room correction factor lighting A

The room correction factor is a measurement for the difference of the brightness measurement on the ceiling and the work area. The brightness measurement value at the ceiling is influenced by the installation location, incidence of light,

position of the sun, weather conditions, the reflection properties of the room, and the furniture.

With the room correction factor, the brightness measurement value of lighting channel A is adjusted to the conditions in the room and in this way can be matched to the lux meter value ① measured at the surface beneath the presence detector.

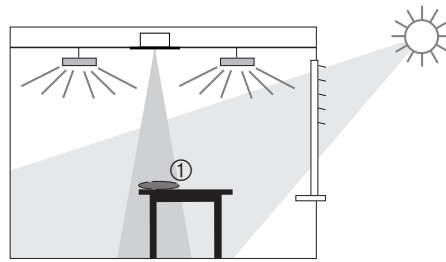

Room correction factor = $\frac{\text{Brightness value at the ceiling}}{\text{brightness value at the working surface}}$

Using management "SendoPro 868-A" remote control and lux meter:

- The lux meter is placed on the work surface below the sensor and the measured lux value is entered via the "SendoPro 868-A" remote control, <brightness measurement value A>.
- The room correction factor is calculated from this automatically. Values between 0.05 and 2.0 are permitted. Calculated or entered values outside the permitted range will automatically be set to the appropriate limit value.
- The calculated room correction factor will be applied immediately. For monitoring purposes, the room correction factor can be queried via the <room correction factor A> parameter.



Using "theSenda B" remote control and "theSenda Plug" app:

- Connect "theSenda B" remote control with the corresponding "theSenda Plug" app.
- Select the appropriate detector type and load the parameter set.
- Press the send button  at the <brightness measurement value A> parameter.
- Follow the instructions of the app.
- The room correction factor is calculated from this automatically. Values between 0.05 and 2.0 are permitted. Calculated or entered values outside the permitted range will automatically be set to the appropriate limit value.
- The calculated room correction factor will be applied immediately. For monitoring purposes, the room correction factor can be queried via the <room correction factor A> parameter.

The standard value is 0.3 and is suitable for most applications. Changes are only sensible in strongly deviating situations.

Detection sensitivity

The detector has 5 sensitivity increments. The basic setting is the middle increment (3). By selecting the test presence operating mode, the set sensitivity increment is not changed. With the "SendoPro 868-A" management remote control, as well as with "theSenda B" app remote control (with "theSenda Plug" app), the increments 1 to 5 can be selected and sent to the detector. With the "theSenda P" installation

remote control, the sensitivity can be decreased  or increased  by one increment each time the button is pushed.

| Increment | Sensitivity |
|-----------|------------------|
| 1 | very insensitive |
| 2 | insensitive |
| 3 | Standard |
| 4 | sensitive |
| 5 | very sensitive |

By selecting the test presence operating mode, the set sensitivity increment is not changed.

Time delay channel A light

Value range

| | |
|---|---|
| Adjustable values "SendoPro 868-A" / "theSenda B" (app) | 10 s–60 min |
| Adjustable values "theSenda P" | 10 s, 30 s, 60 s, 2 min, 10 min, 20 min, 60 min |

| | |
|--|--|
| Control for staircase light timer switch (0.5 s "on" / 10 s "off") | |
| "SendoPro 868-A" / "theSenda B" (app) | Pulse |
| "theSenda P" | Button  |

Short presence channel A light

The time delay of channel A light can be switched off sooner if a room is occupied only for a short time. (In fully automatic device and semi-automatic device configuration type)

| | |
|--|-----|
| The time delay is used according to the set parameter. | Off |
| If someone enters an unoccupied room and it is only occupied for up to 30 s, the light will be switched off prematurely after 2 min. | On |

Time delay channel H presence

Channel H presence always switches in case of a presence, regardless of whether configuration type is set to fully automatic device or semi-automatic. The relay contact opens if the room is vacated only after the set time delay has expired.

Value range

| | |
|---|--|
| Adjustable values "SendoPro 868-A" / "theSenda B" (app) | 10 s – 120 min |
| Adjustable values "theSenda P" | 10 s, 30 s, 60 s, 2 min, 10 min, 20 min, 120 min |

Switch-on delay channel H presence

The relay contact only closes when someone is present after expiry of the set switch-on delay.

Value range

| | |
|-------------------|--|
| Adjustable values | 0 s (no switch-on delay), 30 s, 1–10 min |
|-------------------|--|

Configuration type

| | |
|---|----------|
| Fully automatic device: The lighting is switched on and off automatically. (Due to presence / absence and brightness) | |
| "SendoPro 868-A" / "theSenda B" (app) | auto |
| "theSenda P" | Button A |

| | |
|---|--|
| Semi-automatic: Lights must always be switched on manually. Switching off occurs automatically by the presence detector. (due to absence or brightness) | |
| "SendoPro 868-A" / "theSenda B" (app) | man |
| "theSenda P" | Button  |

Control input S

Control input S for manual switch on/off of channel A light automatically detects push buttons or switches.

Several push buttons can be connected to control input S.

- Use light push button only with neutral conductor connector.

Value range

| | | |
|--|-------------------------------|---------------|
| Automatic detection of push button or switch. A signal that is present for less than 0.7 s is detected as a push button. Longer signals are evaluated as a switch. | | auto |
| To adapt to user behaviour, the type of the used signal transmitter can have a fixed setting. Automatic detection is deactivated. When selecting the push button, opening contact or NO contact can also be specified. | Switch | Switch |
| | Push button (NO contact) | Push button S |
| | Push button (opening contact) | Push button O |

Staircase light function

| | |
|--|-----|
| The lighting can be switched on and off manually. | Off |
| The lighting can be switched on, but not switched off manually. It only switches off after the set time delay. | On |

Group address

This parameter is applied when using the "theSenda S" user remote control.

A group address can be assigned to channel A light.

The group addresses can be programmed with the following remote controls:

Group address value range

| | |
|------------------------------------|-----------------|
| Adjustable values "SendoPro 868-A" | I, II, III, All |
| Adjustable values "theSenda B" | I, II, III |
| Adjustable values "theSenda Plug" | I–VIII, All |
| Adjustable values "theSenda S" | I, II |

LED display motion

The motion detection can be displayed via the LED.

Value range

| | |
|---|-----|
| No display of motion detection. | Off |
| The LED is switched on when motion is detected, otherwise it remains off. | On |

Settings are possible with "SendoPro 868-A" management remote control or with "theSenda B" app remote control (with "theSenda Plug" app).

Factory settings

The thePassa P360-101 UP presence detector is delivered with the following parameter values:

| Parameter | Value |
|-----------------------------|-------------|
| Detection zone | Z1 and Z2 |
| Brightness setpoint value A | 300 lux |
| Room correction factor A | 0.3 |
| Detection sensitivity (PIR) | Increment 3 |
| Time delay A | 10 min |
| Short presence A | On |
| Time delay H | 10 min |
| Switch-on delay H | 0 s |
| Configuration type | auto |
| Control input S | auto |
| Staircase light function | Off |
| Group address | I |
| LED display motion | Off |

9. Start-up

Switch-on behaviour

Every time the power supply is switched on, the presence detector runs through two phases that are shown by an LED:

9.1. Start-up phase (30 s)

- The red LED flashes at one second intervals, both switch contacts are closed (light and presence on).
- The detector does not respond to push button commands and remote control commands.
- When no one is present, both contacts open after 30 s.

9.2. Operation

The detector is ready for operation (LED off).

Presence test

Presence test mode is used to test presence detection and wiring. Presence test mode can be activated with "SendoPro 868-A" management remote control, with "theSenda B" app remote control (with "theSenda Plug" app) and with "theSenda P" installation remote control.





Setting the presence test mode via remote control

The detector goes directly into test mode when the test mode is set via the remote control:

Every movement is indicated by the LED.

- When movement occurs, the light and presence switch contacts close.
- When no one is present, the light switch contact opens after 10 s.
- Brightness measurement deactivated, detector does not react to brightness.
- The detector reacts as in configuration type fully automatic device, even if semi-automatic is set.
- Teach-in cannot be activated in test mode.
- Test mode ends automatically after 10 min. The detector restarts itself (see switch-on behaviour).

10. Technical data

| | |
|---|--|
| Operating voltage | 110-230 V AC + 10% / - 15% |
| Frequency | 50-60 Hz |
| Upstream protection device: | 13 A |
| Power consumption | approx. 0.1 W |
| Type of installation | Ceiling installation; flush / surface mounted or ceiling installation |
| Recommended installation height | 2.0 – 6.0 m |
| Minimum height | > 1.7 m |
| Detection area horizontal | 360° |
| Maximum range | 20 x 5 m (Mh. 3.5 m) / 100 m ² radially moving 30 x 5 m (Mh. 3.5 m) / 150 m ² tangentially moving |
| Setting range brightness setpoint value | 30–3000 lux |
| Light time delay | 10 s – 60 min/pulse |
| Presence time delay | 10 s–120 min |
| Switch-on delay "Presence" | 0 s – 10 min |
| Channel A light | Relay 230 V/10 A, µ-contact |
| Max. switching capacity cos φ 1 resistive | 2300 W  (max. 10 A) |
| Max. switching capacity cos φ 0.5 | 1150 VA    |
| Max. switching capacity LED LED lamp < 2 W LED lamp > 2 W | see manufacturer concerning cos φ 60 W 180 W |
| Guidance values max. switch-on current | 800 A/200 µs |
| Maximum number EBs T5/T8 | 16 x 54/58 W, 24 x 35/36 W 8 x 2x 54/58 W 12 x 2x 35/36 W |
| Channel H, presence | Relay, floating, base insulation |
| Maximum voltage | 220 V DC / 250 V AC |
| Maximum switching capacity | 50 W / 50 VA (max. 2 A) |
| Recommended minimum load | 10 mV / 10 mA |
| Connection type | Screw terminals |
| Max. cable cross-section | Max. 2 x 2.5 mm ² |
| Size of flush-mounted box | Size 1, Ø 55 mm (NIS, PMI) |
| Protection rating | IP 20 (IP 54 installed) |
| Ambient temperature | -15 °C – 50 °C |
| CE Declaration of Conformity | This device conforms to the safety regulations of the EMC directive 2014/30/EU and of directive 2014/35/EU. |

Product overview

| Type of installation | Channel | Operating voltage | Colour | Type | Item number |
|----------------------|--------------|-------------------|-------------------|--------------------------|-------------|
| Ceiling installation | Light HVAC | 110-230 V AC | White | thePassa P360 -101 UP WH | 2010300 |
| Ceiling installation | Light HVAC | 110-230 V AC | Grey | thePassa P360 -101 UP GR | 2010301 |
| Ceiling installation | Light HVAC | 110-230 V AC | Special colour in | thePassa P360 -101 UP SF | 2010303 |

Troubleshooting

| Fault | Cause |
|--|--|
| Light does not switch on or off if presence is detected and in darkness | Lux value is set too low; detector set on semi-automatic; light was switched off manually via button or "theSenda S"; person not within detection area; obstruction(s) interrupting detection; time delay set too short |
| Light stays on with detection of presence despite sufficient brightness | Lux value is set too high; light was briefly switched on manually via button or with "theSenda S" (wait 30 min.); detector is in test mode |
| Light does not switch off, or light switches on spontaneously when no one is present | Wait for time delay (self-learning); thermal sources of interference in the detection area: fan heaters, incandescent lamps/halogen spotlights, moving objects (e.g. curtains hanging in open windows); Load (EBs, relays) not cleared |
| Push button does not work | Device still in the start-up phase; illuminated button was used without neutral conductor; Push button not fed to the Master |
| Light cannot be switched off with the push button | Push button not fed to the detector. Check wiring to the push button. |
| Device does not respond | Short circuit or several phases in parallel switching! Disconnect detector from the power supply for 5 min (thermal fuse) |
| Error flashing (4 x per second) | Error in self-test; device not functional! |

LED display

| LED | Description |
|-----------------------------------|--|
| Flashing at 1 second intervals | The presence detector is in the start-up phase. |
| Flickering for 2 s | The command sent from the remote control via infrared was accepted by the presence detector. |
| Lighting up briefly | The command sent from the remote control via infrared was rejected by the presence detector. The command is not valid. Check the selected detector type or parameters on the SendaPro or in the app. |
| Fast flashing | Error flashing; The presence detector has found an error. |
| Flickering for 20 s | Teach-in via potentiometer is activated. |
| Lights up or flickers irregularly | The presence detector is in presence test mode or "LED display movement" is activated. The LED displays detection of movement. |

Guarantee

Theben HTS presence detectors are manufactured with the utmost care using state-of-the-art technology and are

quality-tested. Theben HTS AG therefore guarantees perfect operation when used correctly. Should a fault occur, Theben HTS AG will fulfil the guarantee within the scope of the general terms and conditions.

Please note in particular:

- that the guarantee period lasts 24 months from the date of manufacture.
- that the guarantee is invalidated if you, or a third party, make changes to or undertake repairs on the devices.
- that, insofar as the presence detectors are connected to a software-controlled system, the guarantee for this connection is only valid when the indicated interface specification is complied with.

We undertake to repair or replace as quickly as possible all components of the delivered device that have become defective or unusable through demonstrably poor material, faulty construction or incomplete delivery up to the end of the guarantee period.

Returns

In the event of a guarantee claim, please return the device to the relevant dealer together with the delivery note and a brief description of the fault.

Industrial property rights

The design as well as hardware and software of these devices are protected by copyright.

Dimensions diagrams

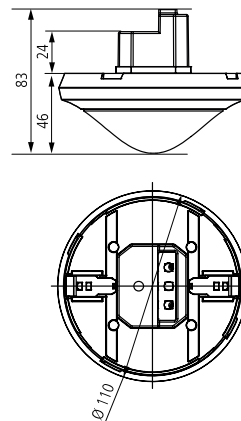

11. Accessories

Back box 110A WH

Item no.: 9070912

Details > www.theben.de/en



Back box 110A GR
Item no.: 9070913
[Details > www.theben.de/en](http://www.theben.de/en)



DE (ceiling installation) box 73A
Item no.: 9070917
[Details > www.theben.de/en](http://www.theben.de/en)



Cover clip for area restriction
Item no.: 9070921
[Details > www.theben.de/en](http://www.theben.de/en)

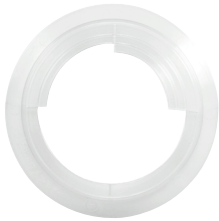

SendoPro 868-A
Item no.: 9070675
[Details > www.theben.de/en](http://www.theben.de/en)



theSenda P
Item no.: 9070910
[Details > www.theben.de/en](http://www.theben.de/en)



theSenda B
Item no.: 9070985
[Details > www.theben.de/en](http://www.theben.de/en)



theSenda S
Item no.: 9070911
[Details > www.theben.de/en](http://www.theben.de/en)



12. Contact

Theben HTS AG
Im Langhag 7b
8307 Effretikon
SWITZERLAND
Phone +41 52 355 17 00
Fax +41 52 355 17 01

Hotline
Phone +41 52 355 17 27
hotline@theben-hts.ch
www.theben-hts.ch

All countries except Switzerland

Theben AG
Hohenbergstraße 32
72401 Haigerloch
GERMANY
Tel.: +49 7474 692-0
Fax: +49 7474 692-150

Hotline
Tel.: +49 7474 692-369
hotline@theben.de
www.theben.de