

theben

307528 01

EN Digital twilight switch

LUNA 111 top3 AL, EL
1110130/1110230

LUNA 112 top3 AL, EL
1120130, 1120230

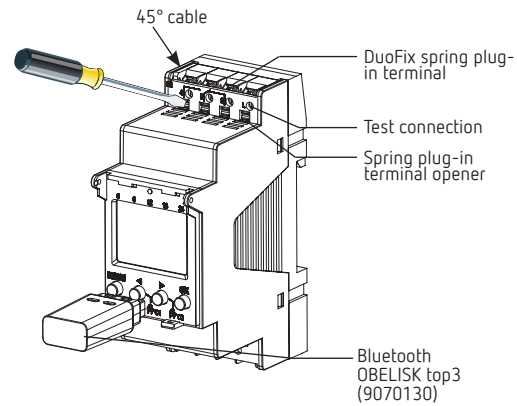

1. Basic safety information



WARNING

Danger of death through electric shock or fire!

- Installation should only be carried out by a qualified electrician!

- The device is designed for installation on DIN top hat rails (in accordance with EN 60715)

2. Proper use

- The digital twilight switch is used for lighting equipment (streets), external stairways, display windows, entrances etc.
- Only for use in closed, dry rooms
- Sensor is installed in the open-air
- Interface for Bluetooth OBELISK top3 (app)



Do not use on safety devices, e.g. escape route doors, fire safety equipment etc.

Disposal

- Dispose of device in environmentally sound manner

3. Installation and connection

Mounting the twilight switch

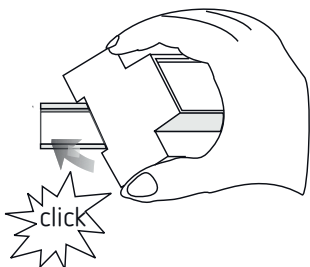

Check the depth of the control cabinet when OBELISK top3 is connected. The depth must be > 94 mm.

- Mount on DIN top hat rail (as defined in EN 60715)
- Disconnect power source
- Ensure device cannot be switched on
- Check absence of voltage
- Earth and bypass
- Cover or shield any adjacent live components

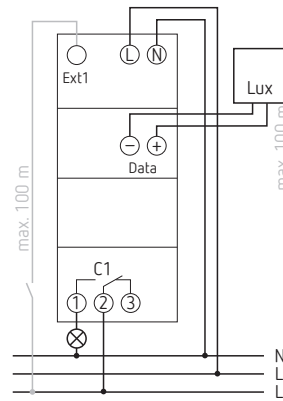

LUNA 111 top3

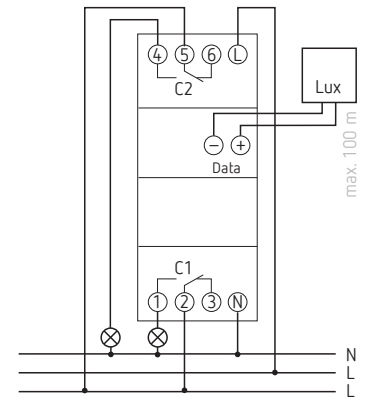

LUNA 112 top3

Connecting the cable

- Strip cable to 8 mm (max. 9)
- Insert cable in the open DuoFix plug-in terminal at 45°
- ① 2 cables per terminal position possible
- To open the DuoFix plug-in terminal, press screwdriver downwards

Disconnecting the cable

- Use the screwdriver to push the load line connection opener downwards

Connection/installation of light sensor

- ⚠ Take length of connection cable into account: max. 100 m (2 x 1.5 mm²), max. 50 m (2 x 0.75 mm²)
- ⚠ Avoid running sensor wiring parallel to mains power cables
- Ensure correct polarity. Connect power source

Mounting light sensor 9070415

- Mounting light sensor: 0.5-2.5 mm², strip cable by 9 mm (max. 10 mm)

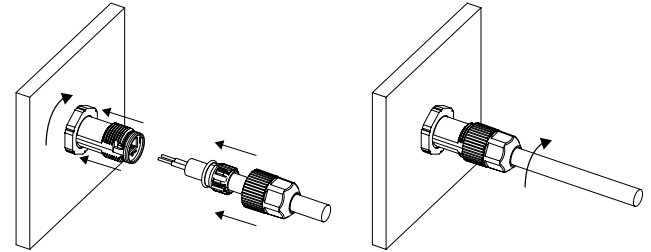
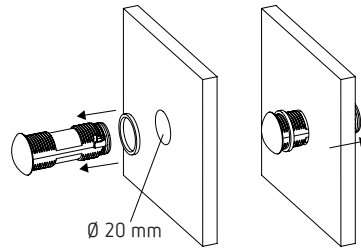
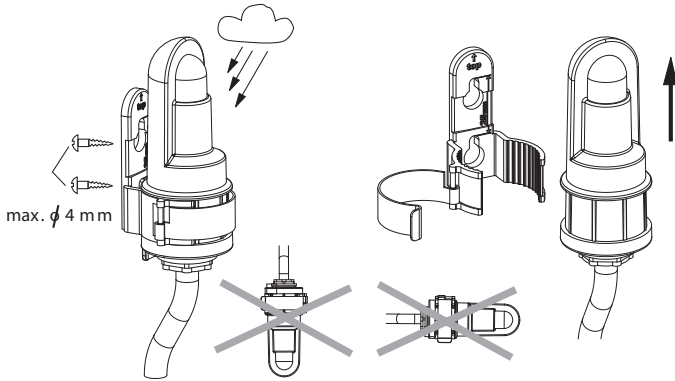

Installing light sensor 9070456

- Installing light sensor: 0.25-1.5 mm², strip cable by 8 mm (max. 9 mm)

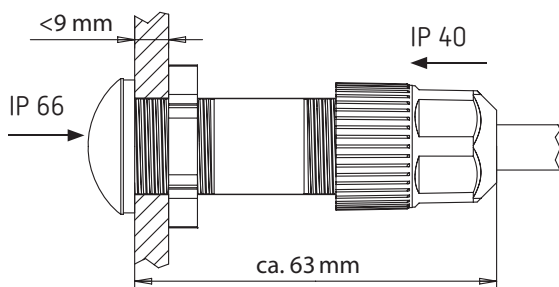
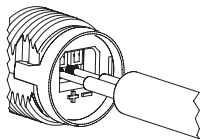
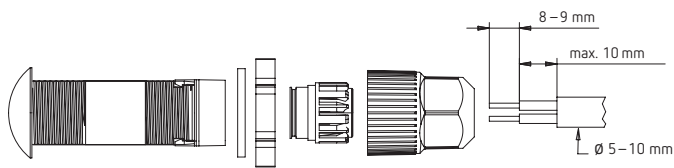

4. Device description

Display & buttons

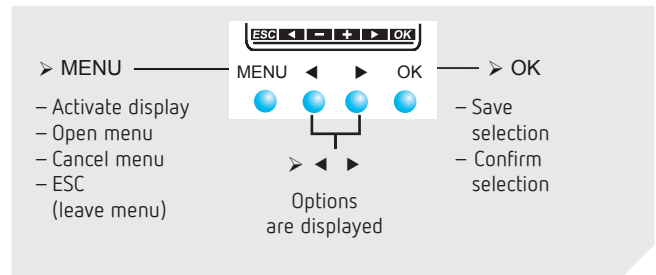
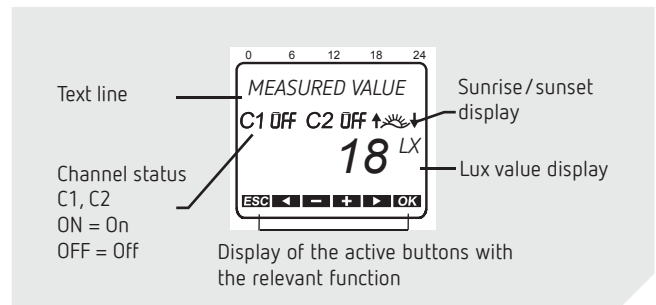

Operating instructions

1. Read text line
text/symbol represents query

2. Make a decision

YES Confirmation Press OK	NO Modify/ Change Press ← →
------------------------------------	---

Overview of navigation menu

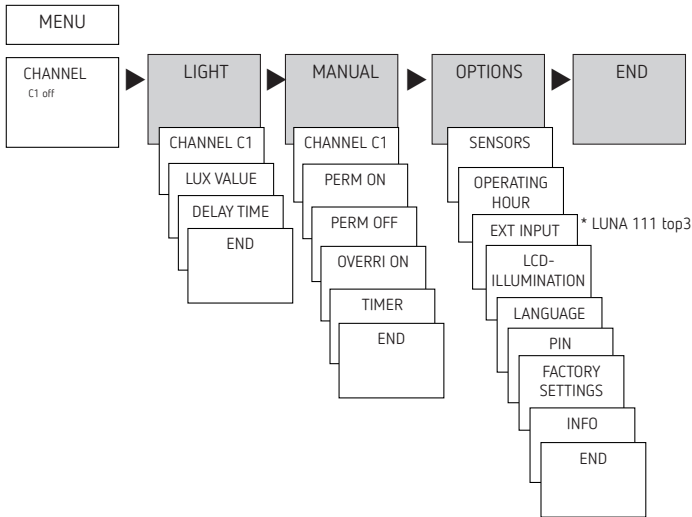

① The device has been preset at 15 lx for the switch on/switch off level

- Press MENU
- Select LIGHT and press OK to confirm
- Select CHANNEL C1 or C2, confirm with OK
- Select LUX VALUE and press OK to confirm
- Select LUX ON and press OK to confirm
- Set LUX VALUE, confirm with OK

Typical brightness values

Daylight (bright)	80.000 lx
Office accommodation	500 lx
Hallways and stairs	100–150 lx
Street lighting	15 lx
Full moon	ca. 0,3 lx

Set delay

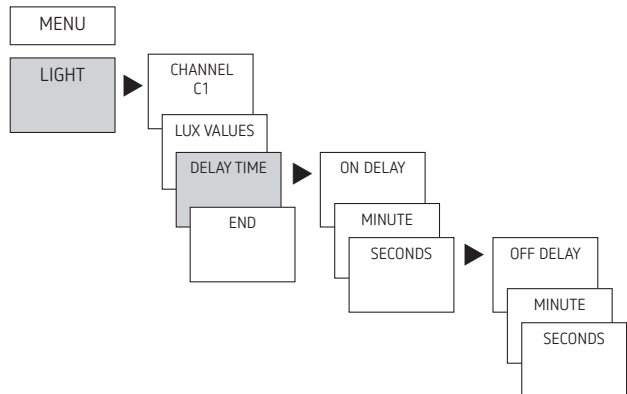

① An on/off delay of 1 minute is preset to avoid faulty operation caused by lightning, car headlights etc. When the delay ends the channel status will flash ON/OFF.

- Press MENU
- Select LIGHT and press OK to confirm
- Select CHANNEL C1 or C2, confirm with OK
- Select DELAY TIME, confirm with OK
- Select ON DELAY, confirm with OK
- MODIFY HOUR, use the + or – buttons to change minute and confirm with OK.

Initial operation

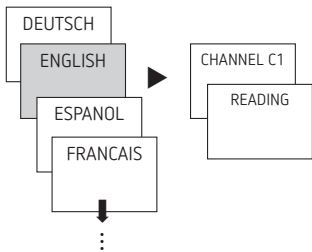

- Set language, press OK to confirm
- Press any button and display follows on screen (see figure)
- ① If all settings are performed, the screen alternately shows the automatic display and READING
- ① If a sensor is connected, the measured lux value appears on screen (only during mains operation).

5. Settings and functions

Set lux values

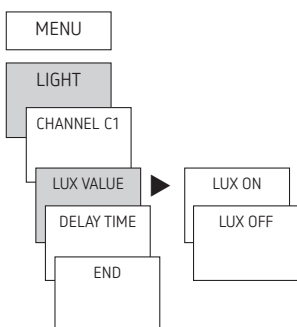

Allocate sensors

① The SENSORS are allocated in the menu under OPTIONS

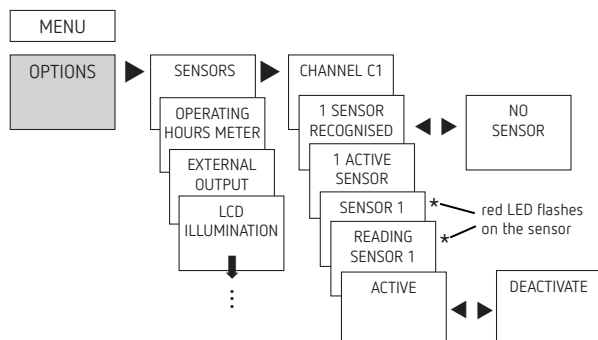

- Press MENU (see fig.)

Connection options:

- 1 LUNA + max. 4 light sensors
- 10 LUNA + 1 light sensors
- Σ max. 16 devices (LUNA + light sensors)

- ① **Presetting:** all connected sensors are active for all channels. The sensor that sends the lowest lux value is active

Activating PIN code

The PIN code is set in OPTIONS via the menu.

- ① If you have forgotten your PIN, call the Theben Hotline.

- ① Have the serial number ready.

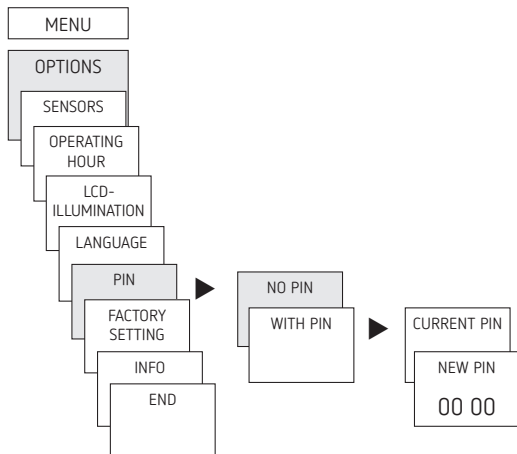

Setting manual or permanent switching

Manual or permanent switching can be set via the menu in MANUAL or (in the automatic screen) by button combination (see picture).

- **Manual control:**
Reversing the channel status to the next automatic or programmed switching.
- **Permanent switching:**
As long as a permanent switching (on or off) is activated, the programmed switching times and switching thresholds are ineffective

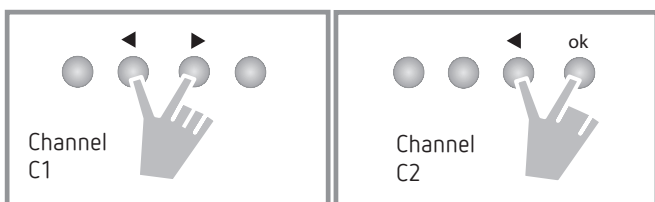

Activating manual control

- Briefly press both buttons simultaneously

Activating permanent switching

- Press both buttons simultaneously for 2 seconds

Cancelling manual/permanent switching

- Press both buttons simultaneously

Set external input (only LUNA 111 top3)

For the channel, an EXTERNAL INPUT (see figure) can be set with different functions.

3 sub-menus can be selected: Inactive, push button (function), switch (function)

- **NOT ACTIVE:** The external input has no function

- **BUTTON:** Manual (manual control), Timer (countdown timer) are selectable
- **SWITCH:** Permanent On, permanent Off are selectable

- ① If a function is activated via an external push button or switch, EXTERNAL is displayed.

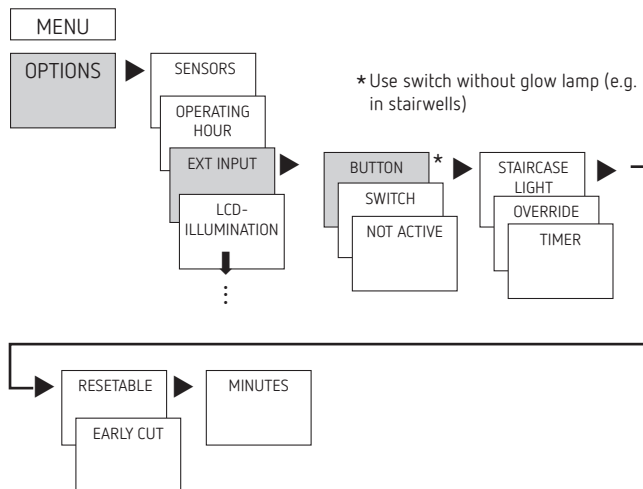

- Press MENU, with ► select EXT INPUT and follow the indications on the display.

- ① Additional power unit required for GPS if only one device is connected to the antenna.

- ① Refer to the operating instructions when connecting a GPS antenna (9070610).

Minimum number of participants needed to operate the GPS antenna:

- 2 x weekly timer TR 611 top3 RC, SELEKTA 171 top3 RC LUNA 121 – 122 top3 RC each with 50 mA feed, or
- 1 x weekly timer with 50 mA feed plus 1 x top2 GPS power unit (9070892) with 50 mA feed

Hour counter

The operating hours of the channel (relay) are displayed and deleted in the OPTIONS menu. If the number of operating hours exceeds the value set in the Service menu, SERVICE will appear in the display.

Example: Replace a lamp after after 5,000 h.

- Delete operating hours or set a higher value in Service (e.g. to 10,000 h)

Using Bluetooth OBELISK top3

All functions can also be transferred to the twilight switch using the Bluetooth OBELISK top3 memory card (9070130).

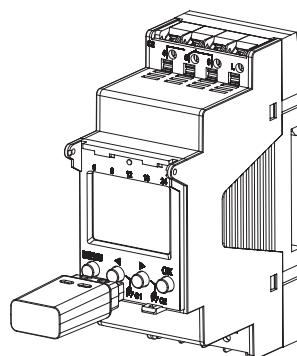

Copying OBELISK → LUNA

Copies the switch program and optionally all twilight switch settings (e.g. external input, time format, etc.) from the memory card to the twilight switch.

Copying LUNA → OBELISK

Copies all switch programs and twilight switch settings to the memory card.

Starting OBELISK program

Applies the thresholds and switching times that are programmed on the memory card and executes them. As soon as the memory card is removed, the switching times of the twilight switch are re-activated.

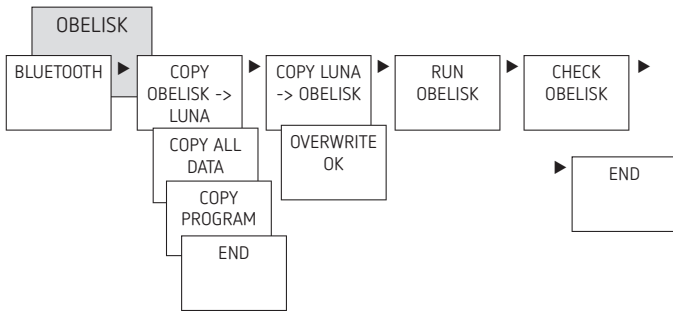

Connecting the twilight switch, Bluetooth OBELISK top3 and smartphone (via app)

The devices in the top3 range can be programmed using an app (for Android, iOS) on a mobile end device. Communication takes place via Bluetooth OBELISK top3. Switching programs are transferred and direct switch commands are sent to the device.

- Download the OBELISK top3 app from the App Store or Google Play Store



ⓘ Bluetooth connection only possible in automatic mode, not in manual mode like OPTIONS, etc.

- Open the app and activate using one of the 3 commands, by pressing „Download“ (📶), „Manual command“ (👉) or „Upload“ (📶)
- Device / device list appears on the display.



- Press „Connect“



- Press OK on the twilight switch
→ The display shows BLUETOOTH ACTIVE
- Press „Connect“ in the app within 30 s



Now, for example, projects can be created and uploaded.



Restarting the twilight switch

- Press the 4 buttons simultaneously
→ You can choose between KEEP PROGRAM and DELETE PROGRAM

6. Technical data

Operating voltage:	110–230 V AC, +10 % / –15 %
Frequency:	50–60 Hz
Standby:	0,8 W
Brightness range:	1–99.000 lx
On/off switch delay:	0–59 min
Switching capacity max.:	16 A (at 250 V, $\cos \varphi = 1$)
Switching capacity:	10 A (at 250 V, $\cos \varphi = 0,6$)
Min. switching capacity:	10 mA/230 V AC 100 mA/24 V AC/DC
Switch output:	Switching of any external conductor is permitted
Shortest switching time:	1 s
Switching accuracy:	to the second
Protection class:	II in accordance with EN 60730-1 subject to designated installation
Software:	class A
Rated impulse voltage:	4 kV
Pollution degree:	2
Contact:	Changeover contact
Incandescent lamp load:	2600 W
Halogen lamp load:	2600 W
Fluorescent lamps: uncorrected:	2600 VA
series-corrected:	2600 VA
parallel-corrected:	1300 VA (130 μ F)
Compact fluorescent tubes (EVG):	1100 W
LED lamps (< 2 W):	50 W
LED lamps (> 2 W):	600 W
Bluetooth OBELISK top3: – Protection rating:	IP 40
– Temperature:	–30 °C ... +55 °C
– Range:	15 m on open air test site
Permissible ambient temperature:	–25 °C ... +55 °C, –40 °C ... +70 °C (sensor)
Protection class:	II (light sensors III) if correctly mounted
Protection rating: device	IP 20
Mounted light sensor	IP 55
Installation light sensor	IP 66 (frontside) IP 40 (backside)

④ The twilight switch display is only fully functional at temperatures from +5 °C ... +55 °C.

7. Contact

Theben AG
Hohenbergstr. 32
72401 Haigerloch
GERMANY
Tel. +49 7474 692-0
Fax +49 7474 692-150

Hotline

Tel. +49 7474 692-369
hotline@theben.de

Addresses, telephone numbers etc.
www.theben.de