



1. Safety information



To rule out the risk of electrical shock or fire, protect the time switch from moisture and heat!



Prior to start-up and using the product, read and observe all the operating instructions.

⚠ Use a single mains socket (230 V~, 50 Hz, earthed) for the power supply.

⚠ Do not plug time switches into each other.

- The time switches conform to EN 60669-2-1 if correctly installed and type 1 BSTU in accordance with IEC/EN 60730-2-7.
- Power reserve (6 years) is reduced when Bluetooth OBELISK top3 is connected (in battery mode).

2. Proper use

- This digital plug-in time switch with weekly program is suitable for indoor use (floor lamp, aquarium, Christmas lights, etc.)
- Interface for Bluetooth OBELISK top3 (+ app)
- For earthed sockets (plug type F)
- Only use in dry, enclosed rooms

⚠ Do not use on safety devices, e.g. escape route doors, fire safety equipment, etc.

3. Installation and connection

- Plug the time switch into a 230 V earthed wall socket and plug the selected device into the socket (F) on the time switch.

4. Device description

Digital plug-in time switch

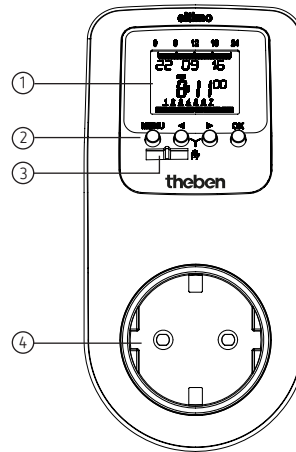

- ① Display with date, time, week days etc.
- ② 4 buttons to operate the device
- ③ Interface for OBELISK top3 memory card (9070130)
- ④ Socket F (and plug on the rear)

Display and buttons

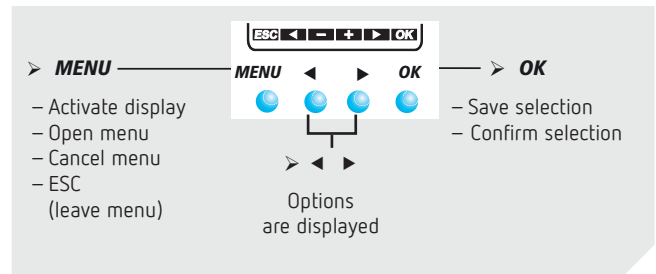
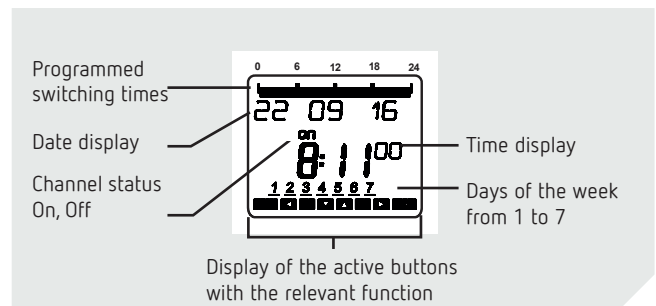

Operating instructions

1. Read text line
text/symbol
represents query

2. Make a decision

YES
Confirmation
Press
OK

NO
Modify/
Change
Press
◀ ▶

Overview of navigation menu

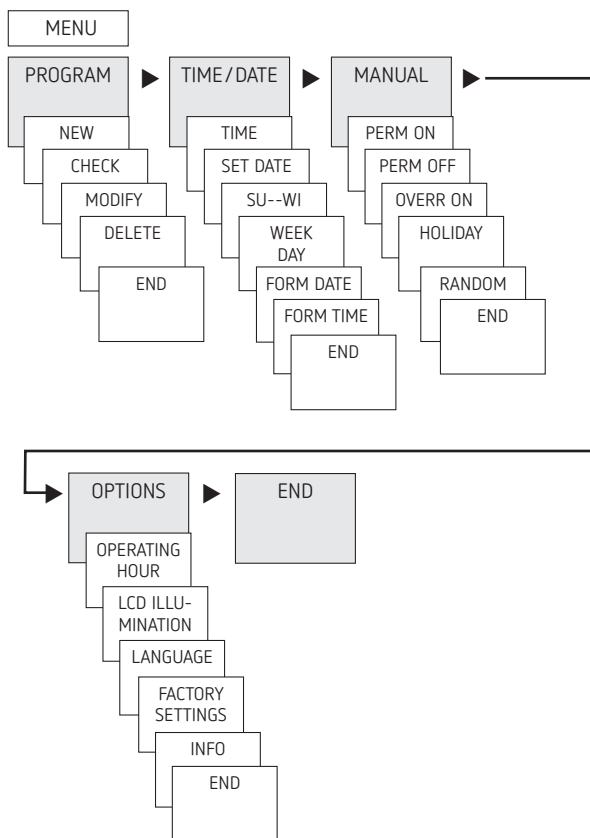

Initial operation

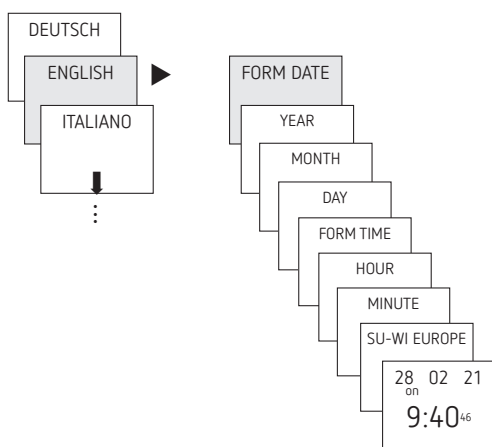

- Set language, date, time as well as summer/winter time (SU-WI).
- Press any button and display follows on screen (see figure).

5. Settings and functions

Set switching time

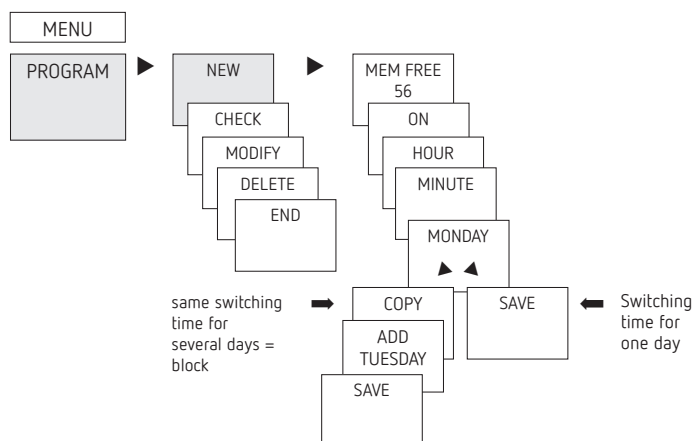

① A switching time always consists of a start time and an end time.

① There are 56 memory cells available.

Example: Switch on sports hall lighting from Mon–Fri, 7:30 to 12:00 hrs

- Press MENU.
- Select PROGRAM and press OK to confirm.
- Select NEW and press OK to confirm.
- Select ON (for turn-on time) or OFF (for turn-off time), confirm with OK.
- Set required turn-on time (Mo–Fr, 7:30), confirm with OK.
- Select COPY, confirm with OK.
- ADD TUESDAY is displayed, confirm by pressing OK and also confirm the days We, Th, Fr by pressing OK.
- Continue with ► until SAVE is displayed.
- Confirm by pressing OK.

Repeat all steps for the turn-off time, however instead of selecting ON with ► select OFF and enter 12:00 for hour and minute.

Change switching times

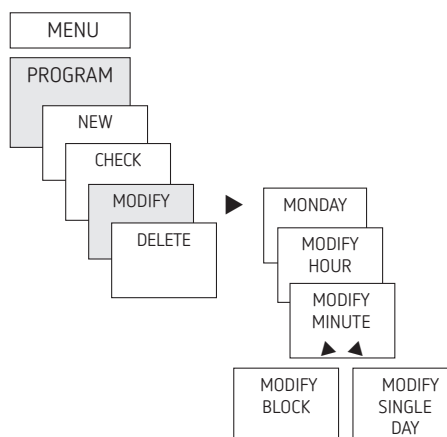

① You can either change or delete a block, i.e. a switching time copied for several days (e.g. Mon–Fri) or a single switching time.

Change individual switching times

- Press MENU.
- Select PROGRAM and press OK to confirm.
- Select MODIFY, confirm by pressing OK.
- Select day, confirm with OK.
- MODIFY HOUR, use the + or – buttons to change hour and minute and confirm with OK.
- To change several switching times, select MODIFY BLOCK, confirm with OK.

Delete switching program

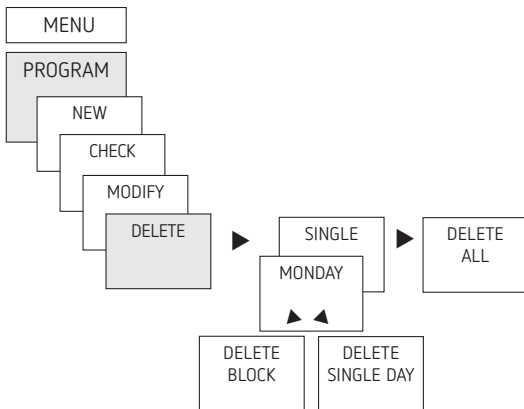

① You can either delete a block, i.e. a switching time copied for several days (e.g. Mon–Fri) or a single switching time

- Press MENU.
- Select PROGRAM and confirm with OK
- Select DELETE, confirm with OK.
- INDIVIDUAL is displayed (with ► DELETE ALL), confirm with OK.
- MONDAY is displayed, confirm with OK.
- Select DELETE BLOCK, confirm with OK.
- With ► DELETE MONDAY etc. individual days can also be cleared.

Setting holiday function

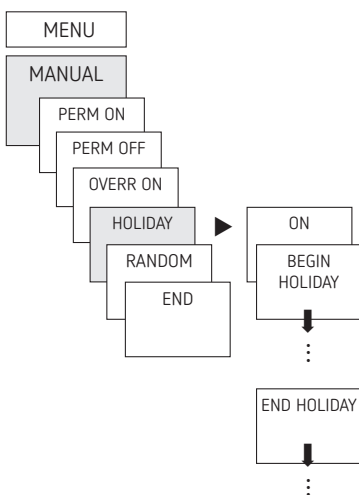

- Press MENU.
- Select MANUAL and press OK to confirm.
- Select HOLIDAY and press OK to confirm.
- Select ON and press OK to confirm.
- Select START HOLIDAY and press OK to confirm.

- Enter YEAR, MONTH, DAY, HOUR and press OK to confirm.
- Select END HOLIDAY and press OK to confirm.
- Enter YEAR, MONTH, DAY, HOUR and press OK to confirm.

Setting the random function

① The consumer is switched on or off at random. If you connect a lamp, you can simulate presence when you are on holiday and make it more difficult for burglars.

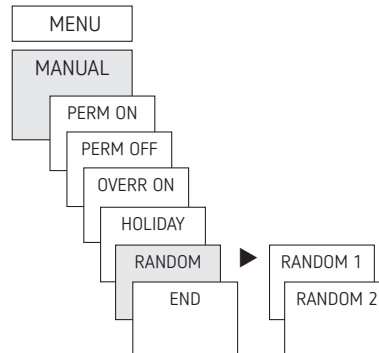

- Press MENU.
- Select MANUAL, confirm with OK.
- Select RANDOM, confirm with OK.
- Select RANDOM 1 or RANDOM 2, confirm with OK.

① **Random 1:** The channel is switched on and off randomly during the programmed ON switching times, and remains completely off during the OFF switching times.

① **Random 2:** The channel is switched on only 1x and switched off again 1x during the programmed ON switching times. However, these ON and OFF switches do not occur exactly at the programmed times, but are offset by a random time.

Setting manual or permanent switching

Manual or permanent switching can be set via the menu in MANUAL or (in the automatic screen) by button combination (see picture).

- Manual control:
Reversing the channel status to the next automatic or programmed switching.
- Permanent switching:
As long as a permanent switching (on or off) is activated, the programmed switching times are ineffective

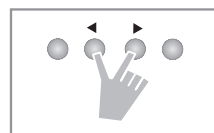

Activating manual control

- Briefly press both buttons simultaneously.

Activating permanent switching

- Press both buttons simultaneously for 2 seconds.

Cancelling manual/permanent switching

- Press both buttons simultaneously.

Hour counter

The operating hours of the channel (relay) are displayed and deleted in the OPTIONS menu. If the number of operating hours exceeds the value set in the Service menu, SERVICE will appear in the display.

Example: Replace a lamp after after 5,000 h.

- Delete operating hours or set a higher value in Service (e.g. to 10,000 h)

Using Bluetooth OBELISK top3

All functions can also be transferred to the time switch using the Bluetooth OBELISK top3 memory card (9070130).

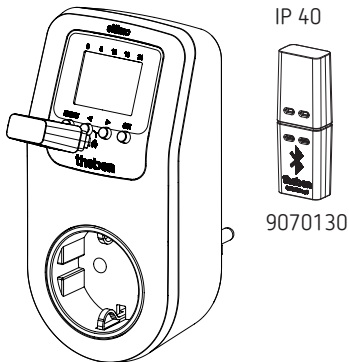

Copying OBELISK → TIME SWITCH

This copies the switching program and optionally all time switch settings (e.g. time format etc.) from the memory card in the time switch.

Copying TIME SWITCH → OBELISK

This copies all switch programmes and settings from the time switch to the memory card.

Starting OBELISK program

Takes on the switching times that are programmed on the memory card.

As soon as the memory card is removed, the switching times of the time switch are re-activated.

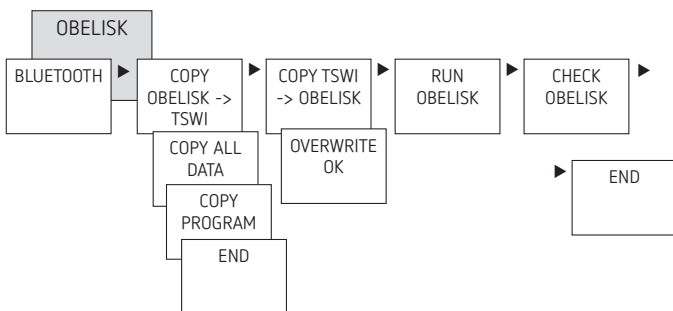

Connecting the plug-in time switch, OBELISK top3 Bluetooth and smartphone (via app)

The devices in the top3 range can be programmed using an app (for Android, iOS) on a mobile end device. Communication takes place via Bluetooth OBELISK top3. Switch programmes are transferred and direct switch commands are sent to the device.

- ① To use the app, you need the OBELISK top3 memory card/dongle.

- Download the OBELISK top3 app from the App Store or Google Play Store



- Open the app and activate using one of the 3 commands, by pressing „Download“ (📶), „Manual command“ (🔊) or „Upload“ (📶)
 - Device / device list appears on the display.

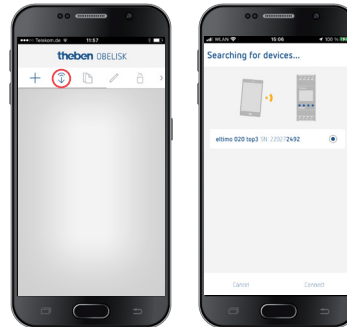

- Press „Connect“.



- Press OK on the timer.
 - The display shows BLUETOOTH ACTIVE.
- Press „Close“ in the app within 30 s.

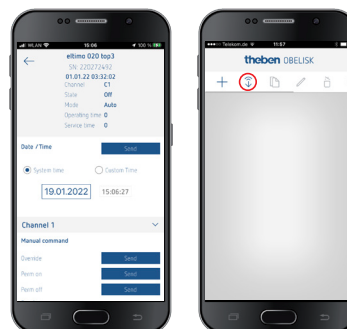

Now, for example, projects can be created and uploaded.

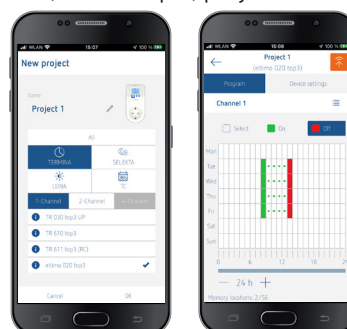

Resetting the time switch

- Press the 4 buttons simultaneously.
 - You can choose between KEEP PROGRAM and DELETE PROGRAM.

6. Technical data

Operating voltage:	230 V AC, +10 % / - 15 %
Frequency:	50 Hz
Standby:	0,9 W
Max switching capacity:	16 A (at 250 V, $\cos \varphi = 1$)
Switching capacity:	10 A (at 250 V, $\cos \varphi = 0,6$)
Min. switching capacity:	10 mA/230 V AC
Shortest switching time:	1 min
Switching accuracy:	accurate to the second
Protection rating:	IP 20 in accordance with EN 60529
Protection class:	II (housing), I (plug system) in accordance with EN 60730-1
Mode of operation:	type 1 BSTU
Operating temperature:	-10 °C ... +40 °C
Power reserve:	6 years at +20 °C (without Bluetooth OBELISK top3)
Time accuracy (typical):	$\pm 0,25$ s/day (25 °C)
Glow lamp load:	2600 W
Halogen lamp load:	2600 W
Fluorescent lamp load: uncorrected/series corrected: parallel-corrected:	2600 VA 600 VA (72 μ F)
Compact fluorescent tubes (EVG):	1100 W
LED lamps (< 2 W):	30 W
LED lamps (> 2 W):	300 W
Resistive switching load:	3680 W
Rated impulse withstand voltage:	2,5 kV
Pollution degree:	2
Software class:	A
Bluetooth OBELISK top3: – Protection rating: – Temperature: – Range:	IP 40 -30 °C to +55 °C 15 m on open air test site

- ① The time switch display is only fully functional at temperatures from +5 °C ... +40 °C.

Cleaning and service

- Only use a dry, soft cloth to clean the device surface.
- Do not use any cleaning agents or solvents.

Disposal

- Dispose of device in environmentally sound manner (electronic waste).

Dimensional drawings

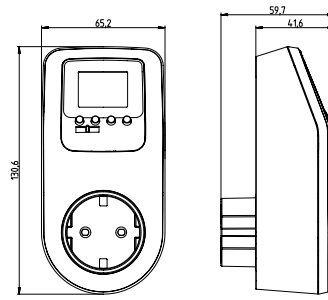

7. Contact

Theben AG
Hohenbergstr. 32
72401 Haigerloch
GERMANY
Tel. +49 7474 692-0
Fax +49 7474 692-150

Hotline
Tel. +49 7474 692-369
hotline@theben.de

Addresses, telephone numbers etc.
www.theben.de