

# KNX manual

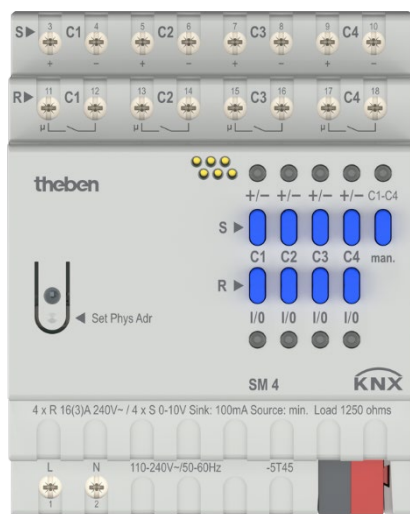





## Switch/dimming actuator

### SM 4 KNX



4940310

## Contents



1	Features	3
2	Operation	4
2.1	Control channels: C1-C4 Control 	4
2.2	Switching channels: C1-C4 Relay 	5
2.3	Colour control	5
3	Technical data	6
3.1	General	6
3.2	Control outputs C1-C4 	7
3.3	Switching channels C1-C4 	7
4	General information about KNX Secure	8
4.1	Start-up with "KNX Data Secure"	8
4.2	Start-up without "KNX Data Secure"	9
5	The SM 4 application programme	10
5.1	Selection in the product database	10
5.2	Overview of communication objects	11
5.3	Description of communication objects	13
5.4	Parameter pages overview	21
5.5	General parameters	22
5.6	Parameter for the control channel 	24
5.7	Parameters for the switching channels 	42
6	Application examples	58
6.1	1-10 V lighting control	58
6.2	Colour temperature control 0-10 V	61
6.3	Colour control RGBW (0-10 V)	65
7	Appendix	68
7.1	Priorities	68
7.2	Using the soft switch function	69
7.3	Using the force function	75
7.4	4-bit telegrams (brighter/darker)	76
7.5	Scenes	78
7.6	Conversion of percentages to hexadecimal and decimal values	82

## 1 Features

- 4-way switch/dimming actuator
- Secure start-up and communication by supporting KNX Data Secure
- 4 relay outputs (bistable), coupled to a control channel or as an individual switch actuator channel.
- Depending on the application, the relay outputs of the switch/dimming actuator are coupled with a control channel or can be used as an individual switch actuator channel.
- When used as a separate switch actuator channel, further functions such as triggering the switching when the threshold is exceeded (DPT5.x, DPT7.x, DPT9.x), logical operations (AND, OR, XOR), flashing, delay or staircase light function are available.
- 4 control channels for controlling electrical consumers which have a 1-10 V interface (passive/sink) or 0-10 V interface (active/source).  
These are typically ballasts for lighting technology (EBs or LED control units), or valve or ventilation controls.
- 4 possible applications easily selectable for the control channels (individual control, colour temperature, RGB or RGBW)
- Soft dimming function for staircase light or passage areas
- Dimming value limitation controllable via object for e.g. night light function
- Scene control with 8 individual scenes per channel (scenes 1...64)
- LED switching status indicator for each channel
- Manual operation on device

## 2 Operation

The device has 2 types of channels:

- 4 control channels, marked with 
- 4 switching channels, marked with 

For maximum flexibility, each of these can work separately or in combination with each other if required.

### 2.1 Control channels: C1-C4 Control

---

 The control channels are analogue voltage outputs with max. 0..10 V DC.  
They are operated in the same way as a dimmer.

---

#### Channel buttons

Each control channel has the two buttons "+" and "-". These buttons can be used to operate the outputs (e.g. C1 + -) manually. When pressing repeatedly, the increments of 0% – 25% – 50% – 75% – 100% are selectable.

The set minimum dimming value is observed with the increments.

Manual operation of the channels via the channel buttons can be blocked or enabled via a general parameter. The enable applies to the entire device. Individual channels cannot be set.

#### Manual button

The device can be set to Manual mode via button or object. Bus telegrams are not processed in Manual mode. The objects received during Manual mode will not be caught up.

The function of the Manual button can be blocked or enabled via a general parameter.

An activated Manual applies to the duration of the time, which can be set via the parameter. After that, Manual will be automatically deactivated.

After a bus failure, Manual mode will be reset.

#### LED display

##### Manual mode

Manual mode is displayed via an LED.

When active, the LED lights up.

If Manual mode is blocked by parameters, the LED flashes when the button is pressed.

##### Channel

Each channel has two LEDs. The upper one shows the current state of the channel. The LED is on when the dimming value is > 0%.

If the operation of the buttons is blocked by parameters, the LED associated with the button flashes while the button is pressed.

## 2.2 Switching channels: C1-C4 Relay —

---

**i** The switching channels can be used in 2 different ways: Either as a switch actuator or as a switch contact for the control channel.

---

The function of the switching channels is defined on the **General** parameter page:

- Use as independent switch actuator channel, (e.g. C1 Relay)
- Use as a switch contact for the respective control channel (switching the controlled device on/off). In this case, the relay has no parameters of its own, the channel, e.g. C1 Relay, is hidden.

## 2.3 Colour control

---

**i** For colour control, up to 4 control channels are coupled with each other. Configuration is made in control channel C1.

---



---

**i** For this, see parameter *Type of control* on the **General** parameter page.

---

### 2.3.1 Assignment of output terminals for colour control

Depending on the type of colour control (type of control), up to 4 analogue outputs are required.

Type of control	C1 + -	C2 + -	C3 + -	C4 + -
Colour temperature	Warm white	Cold white	free <sup>1</sup>	free <sup>2</sup>
Colour RGB	Red	Green	Blue	free <sup>3</sup>
Colour RGBW	Red	Green	Blue	White

---

<sup>1</sup> The channel is freely available as a standard control channel without colour control

<sup>2</sup> The channel is freely available as a standard control channel without colour control

<sup>3</sup> The channel is freely available as a standard control channel without colour control

## 3 Technical data

### 3.1 General

Bus voltage	KNX: 21–32 V DC
Bus current KNX	<10 mA
Operating voltage	110–240 V AC, +10% / –15%
Frequency	50–60 Hz
Standby output	< 0.5 W
L x W x D	90 x 72 x 70 mm
Type of installation	Series mounting, DIN-rail
Connection type	Screw terminals   bus connection: KNX bus terminal
Max. cable cross-section	Solid: 0.5 mm <sup>2</sup> (Ø 0.8) to 6 mm <sup>2</sup>   stranded wire with crimp terminal: 0.5 mm <sup>2</sup> to 4 mm <sup>2</sup>
Protection rating	IP 20 in accordance with EN 60529
Protection class	II subject to designated Installation
Pollution degree	2
Rated impulse voltage:	4 kV

### 3.2 Control outputs C1-C4

Number	4
Output voltage	0 – 10 V DC
Type of output	Active (source) or passive (sink)
Min. load (active/source)	1250 $\Omega$
Max. current (passive/sink)	100 mA
Short circuit/overload protection	Yes

### 3.3 Switching channels C1-C4

Number of relay outputs	4
Type of contact	$\mu$ contact; NO contact; the switching of any phase is permitted
Contact gap	< 3 mm
Switching capacity	10 A (at 240 V AC, $\cos \varphi = 1$ ), 3 A (at 240 V AC $\cos \varphi = 0.6$ )
Minimum load	100 mA
Switching SELV	Possible if all channels of a module switch SELV
Incandescent/halogen lamp load	1200 W
Fluorescent lamp load (EB)	1100 W
LED lamps	< 2 W: 55 W > 2 W: 600 W
Inrush current	Max. 800 A/200 $\mu$ s
C-load	133 $\mu$ F

## 4 General information about KNX Secure

ETS5 Version 5.5 and higher support secure communication in KNX systems. A distinction is made between secure communication via the IP medium using KNX IP Secure and secure communication via the TP and RF media using KNX Data Secure. The following information refers to KNX Data Secure.

In the ETS catalogue, KNX products supporting “KNX Secure” are clearly marked. 

As soon as a “KNX-Secure” device is included in the project, the ETS requests a project password. If no password is entered, the device is included with Secure Mode deactivated. However, the password can also be entered or changed later in the project overview.

### 4.1 Start-up with “KNX Data Secure”

For secure communication, the FDSK (Factory Device Setup Key) is required. If a KNX product supporting “KNX Data Secure” is included in a line, the ETS requires the input of the FDSK. This device-specific key is printed on the device label and can either be entered by keyboard or read by using a code scanner or notebook camera.

Example of FDSK on device label:



After entering the FDSK, the ETS generates a device-specific tool key. The ETS sends the tool key to the device to be configured via the bus. The transmission is encrypted and authenticated with the original and previously entered FDSK key. Neither the tool key nor the FDSK key are sent in plain text via the bus.

After the previous action, the device only accepts the tool key for further communication with the ETS.

The FDSK key is no longer used for further communication, unless the device is reset to the factory setting: In this case, all set safety-related data will be deleted.

The ETS generates as many runtime keys as needed for the group communication you want to protect. The ETS sends the runtime keys to the device to be configured via the bus.

Transmission takes place by encrypting and authenticating them via the tool key. The runtime keys are never sent in plain text via the bus.

The FDSK is saved in the project and can be viewed in the project overview.

All keys for this project can also be exported (backup).

During project planning, it can be defined subsequently which functions/objects are to communicate securely. All objects with encrypted communication are identified by the “Secure” icon in the ETS.





## 4.2 Start-up without “KNX Data Secure”

Alternatively, the device can also be put into operation without KNX Data Secure. In this case, the device is unsecured and behaves like any other KNX device without KNX Data Secure function.

To start up the device without KNX Data Secure, select the device in the 'Topology' or 'Devices' section and set the 'Secure start up' option in the 'Properties' area of the 'Settings' tab to 'Disabled'.

## 5 The SM 4 application programme

### 5.1 Selection in the product database

Manufacturer	<a href="#">Theben AG</a>
Product family	Dimmers
Product type	SM 4
Programme name	SM 4

Number of communication objects	44
Number of group addresses	254
Number of associations	255



The ETS database can be found on our website: [www.theben.de/downloads](http://www.theben.de/downloads)

---

## 5.2 Overview of communication objects

### 5.2.1 Channel C1 Control

No.	Object name	Function	Length	R	W	C	T	DPT
1	Channel C1 Control	Switching ON/OFF	1 bit	-	W	C	-	1.001
2	Channel C1 Control	Brighter/darker	4 bit	-	W	C	-	3.007
3	Channel C1 Control	Dimming value	1 byte	-	W	C	-	5.001
4	Channel C1 Control	Soft switching	1 bit	-	W	C	-	1.001
5	Channel C1 Control	Block	1 bit	-	W	C	-	1.001
6	Channel C1 Control	Call up/save scenes	1 byte	-	W	C	-	18.001
7	Channel C1 Control	Block scenes = 1	1 bit	-	W	C	-	1.001
		Enable scenes = 1	1 bit	-	W	C	-	1.001
8	Channel C1 Control	Force = 1	1 bit	-	W	C	-	1.001
		Force = 0	1 bit	-	W	C	-	1.001
		Dimming value with force	1 byte	-	W	C	-	5.001
		Force	2 bit	-	W	C	-	2.001
9	Channel C1 Control	Dimming value limitation	1 byte	-	W	C	-	5.001
10	Channel C1 Control	Feedback On/Off	1 bit	R	-	C	T	1.001
11	Channel C1 Control	Feedback in %	1 byte	R	-	C	T	5.001
12	Channel C1 Control	Time to next service	4 bytes	R	-	C	T	13.100
		Operating hours feedback	4 bytes	R	-	C	T	13.100
13	Channel C1 Control	Service required	1 bit	R	-	C	T	1.001
14	Channel C1 Control	Reset service	1 bit	-	W	C	-	1.001
	Channel C1 Control	Reset operating hours	1 bit	-	W	C	-	1.001
15	Channel C1 Control	Switching ON/OFF (RGB red)	1 bit	-	W	C	-	1.001
16	Channel C1 Control	Switching ON/OFF (RGB green)	1 bit	-	W	C	-	1.001
17	Channel C1 Control	Switching ON/OFF (RGB blue)	1 bit	-	W	C	-	1.001
18	Channel C1 Control	Switching ON/OFF white	1 bit	-	W	C	-	1.001
19	Channel C1 Control	Colour temperature	2 bytes	-	W	C	-	7.600
		Colour control RGB	3 bytes	-	W	C	-	232.600
		Colour control RGBW	6 bytes	-	W	C	-	251.600
20	Channel C1 Control	Colour control RGB (red)	1 byte	-	W	C	-	5.001
		Relative colour temperature	1 byte	-	W	C	-	5.001
		Colour control (colour hue)	1 byte	-	W	C	-	5.003
21	Channel C1 Control	Colour control (saturation)	1 byte	-	W	C	-	5.001
		Colour control RGB (green)	1 byte	-	W	C	-	5.001
22	Channel C1 Control	Colour control RGB (blue)	1 byte	-	W	C	-	5.001
23	Channel C1 Control	Colour control white	1 byte	-	W	C	-	5.001
24	Channel C1 Control	Colour temperature change	4 bit	-	W	C	-	3.007
		Colour change (colour hue)	4 bit	-	W	C	-	3.007
		Colour change RGB (red)	4 bit	-	W	C	-	3.007
25	Channel C1 Control	Colour change (saturation)	4 bit	-	W	C	-	3.007
		Colour change RGB (green)	4 bit	-	W	C	-	3.007
26	Channel C1 Control	Colour change RGB (blue)	4 bit	-	W	C	-	3.007

No.	Object name	Function	Length	R	W	C	T	DPT
27	Channel C1 Control	Colour change white	4 bit	-	W	C	-	3.007
28	Channel C1 Control	Colour temperature status	2 bytes	R	-	C	T	7.600
		Colour status RGB	3 bytes	R	-	C	T	232.600
		Colour status RGBW	6 bytes	R	-	C	T	251.600
29	Channel C1 Control	Colour status (RGB red)	1 byte	R	-	C	T	5.001
		Colour status (colour hue)	1 byte	R	-	C	T	5.003
30	Channel C1 Control	Colour status (RGB green)	1 byte	R	-	C	T	5.001
		Colour status (saturation)	1 byte	R	-	C	T	5.001
31	Channel C1 Control	Colour status (RGB blue)	1 byte	R	-	C	T	5.001
32	Channel C1 Control	Colour status white	1 byte	R	-	C	T	5.001

## 5.2.2 Channel C1 Relay

No.	Object name	Function	Length	R	W	C	T	DPT
41	Channel C1 Relay	Threshold as a percentage	1 byte	-	W	C	-	5.001
		Threshold 0..255	1 byte	-	W	C	-	5.010
		Threshold EIS 5 (DPT9.xxx)	2 bytes	-	W	C	-	9.x
		Threshold 0..65535	2 bytes	-	W	C	-	7.001
		Switch object	1 bit	-	W	C	-	1.001
42	Channel C1 Relay	Logic input in AND gate	1 bit	-	W	C	-	1.002
		Logic input in OR gate	1 bit	-	W	C	-	1.002
		Logic input in XOR gate	1 bit	-	W	C	-	1.002
43	Channel C1 Relay	Block = 1	1 bit	-	W	C	-	1.001
		Enable = 1	1 bit	-	W	C	-	1.001
44	Channel C1 Relay	Call up/save scenes	1 byte	-	W	C	-	18.001
45	Channel C1 Relay	Enable scenes = 1	1 bit	-	W	C	-	1.003
		Block scenes = 1	1 bit	-	W	C	-	1.001
46	Channel C1 Relay	Switching with priority	2 bit	-	W	C	-	2.001
47	Channel C1 Relay	On/Off feedback	1 bit	R	-	C	T	1.001
48	Channel C1 Relay	Operating hours feedback	4 bytes	R	-	C	T	13.100
		Time to next service	4 bytes	R	-	C	T	13.100
49	Channel C1 Relay	Service required	1 bit	R	-	C	T	1.001
50	Channel C1 Relay	Reset service	1 bit	-	W	C	-	1.001
		Reset operating hours	1 bit	-	W	C	-	1.001

## 5.2.3 Common objects

No.	Object name	Function	Length	R	W	C	T	DPT
241	Manual button	set/reset	1 bit	-	W	C	-	1.001
242	Report manual button	report	1 bit	R	-	C	T	1.001
243	Central permanent	ON	1 bit	-	W	C	-	1.001
244	Central permanent	OFF	1 bit	-	W	C	-	1.001
245	Central switching	ON/OFF	1 bit	-	W	C	-	1.001
246	Central scenes	Call up/save	1 byte	-	W	C	-	18.001

## 5.3 Description of communication objects

### 5.3.1 Objects for the control channel

#### Object 1: Switching ON/OFF

1 = switch on.

0 = switch off load.

See also: parameter *Switch on value*.

#### Object 2: Brighter/darker

This object is actuated with 4-bit telegrams (DPT 3.007 Control\_Dimming).

This function can be used to incrementally dim the light up or down.

In the standard application, telegrams are sent with 64 increments.

IMPORTANT: The response to 4-bit telegrams depends on the parameter Switching On and Off with a 4-bit telegram.

See appendix: [\*4-bit telegrams \(brighter/darker\)\*](#)

#### Object 3: Dimming value

This object can be used to select the desired dimmer setting directly.

Format: 1 byte percentage value.

0 = 0%

255 = 100%

#### Object 4: Soft switching

A 1 on this object starts a soft switching cycle, i.e.:

The brightness is gradually increased, starting from the minimum brightness.

Afterwards, the dimming value remains constant for the configured time. After this time has elapsed, the light is gradually dimmed down to the configured value after Soft OFF.

The configured minimum and maximum dimming value must be taken into account.

The cycle can be extended or prematurely terminated via telegrams.

This sequence can also be controlled using a time switch if the Time between soft ON and soft OFF parameter is set to Until soft OFF telegram.

The dimming cycle is then started with a 1 and finished with a 0.

See appendix: [\*Using the soft switch function\*](#)

#### Object 5: Block

Responses to the block being set and cancelled can be configured if the block function has been activated (**Configuration options Channel C1** parameter page).

The block only applies when the object is received, i.e. with 0 the channel is not blocked after restoration of the bus supply.

If the parameter Behaviour when setting the block = no reaction, a running soft-switch process will not be interrupted.

## Object 6: Call up/save scenes

Only available if the scene function has been activated (**Configuration options** parameter page).

This object can be used to save and subsequently call up scenes.

Saving stores the dimming value of the channel.

It does not matter how this dimming value is produced (whether via switch commands, central objects or the buttons on the device).

The saved dimming value is restored when it is called up.

All scene numbers from 1 to 63 are supported.

The channel can participate in up to 8 scenes.

See appendix: [Scenes](#)

## Object 7: Enable scenes = 1, block scenes = 1

Blocks the scene function with a 1 or a 0 depending on the configuration.

As long as it is blocked, scenes cannot be saved or called up.

## Object 8: Force, dimming value during force, force = 1, force = 0

The function of the force object can be configured as a 1-bit, 2-bit or 1-byte object.

Format of force object	Force		Response with force	
	trigger with	end with	Begin	End
1 bit	1 or 0 (configurable)	0 or 1 (configurable)	configurable in the application programme	
2 bit	Force On = 3 Force Off = 2	Deactivate force = 0 or 1	configurable in the application programme.	The last dimming value before force is restored
1 byte	1-100%	0	The triggering telegram acts simultaneously as a force dimming value	The last dimming value before force is restored

## Object 9: Dimming value limitation

The dimming value can be temporarily restricted via object Dimming value limitation. This is used, for example, to ensure that basic lighting is not exceeded at night, while during the evening the full range of lighting can be used.

If the object value = 0, the dimming value is not restricted.

If the object value is greater than 0, then this value indicates the limit for the dimming value.

If the object value is smaller than the configured minimum dimming value, then the brightness is restricted to this minimum dimming value.

If the restriction is removed, the dimming value continues to remain restricted until a new dimming command is received.

During the restriction, the Soft ON and Soft OFF times are adjusted in such a way that the speed of the brightness change remains the same as when there are no restrictions.

## Object 10: Feedback On/Off

Sends the current dimming status:

1 = current dimming value is between 1% and 100%

0 = current dimming value is 0%

## Object 11: Feedback in %

Sends the new dimming value after a change as soon as a dimming process is completed, i.e. once the new set point value has been reached.

Format: 1 byte, 0 ... 255 i.e. 0 ... 100%

## Object 12: Operating hours feedback, time to next service

Only available if the operating hours counter function has been activated (**Configuration options** parameter page).

Reports, depending on selected type of hour counter (**Hour counter and Service** parameter page), either the remaining time to the next set service or the current status of the hour counter.

## Object 13: Service required

Only available if the hour counter function has been activated (**Configuration options** parameter page) and Type of hour counter = Counter for time to next service.

Reports if the next service is due.

0 = not due

1 = service interval has expired

## Object 14: Reset service, reset operating hours

Only available if the hour counter function is activated. (**Configuration options** parameter page).

## 5.3.2 Objects for colour control

### Object 19 Colour temperature

Receives colour temperature telegrams from 1000 to 10000 K.

### Object 15 to 32: Colour control RGB/RGBW

**i** With these colour values, the colour components can either be sent together in one object or separately to several objects.  
In HSV or HSVW format, the output is exclusively via separate objects.

**i** HSV values are converted internally into RGB values before processing. After that, the process continues with RGB.

The colour value (hue) corresponds to the angle in the colour wheel, with a transition between colours every 60°. Colour angle 0° for red, 120° for green and 240° for blue.

The saturation determines the purity of the colour. 0% corresponds to neutral grey and 100% corresponds to saturated, i.e. the pure colour.

The brightness value indicates the brightness in %. The values range from 0% no brightness to 100% full brightness. This value corresponds to the dimming value. Thus, there is no separate object for the V-value.

RGB can be calculated from H and S. Together with the dimming value, it results in the control value.

Function	Output	No.	Object function
RGBW Switching ON/OFF (switching colour)	RGB/RGBW separate objects	15	RGB(W) red
		16	RGB(W) green
		17	RGB(W) blue
	RGBW separate objects	18	RGB(W) white
Colour temperature	Colour temperature 2 bytes	19	Colour temperature
	Colour temperature 1 byte	20	Relative colour temperature
	Colour change 4 bits	24	Colour temperature change
	Colour status 2 bytes	28	Colour temperature status
RGB colour control (approaching a fixed value)	RGB 3 bytes	19	Colour control RGB
	RGB separate objects	20	RGB red
		21	RGB green
		22	RGB blue
	HSV separate objects	20	HSV colour hue
		21	HSV saturation
		3	Dimming value (brightness)
RGB colour change (moving by a certain value)	RGB separate objects	24	RGB red
		25	RGB green
		26	RGB blue
	HSV separate objects	24	HSV colour hue
		25	HSV saturation
		3	Dimming value (brightness)
		28	Colour status RGB
RGB colour status	RGB 3 bytes	28	Colour status RGB



Function	Output	No.	Object function
(send value on bus)	<i>RGB separate objects</i>	29	<i>RGB red</i>
		30	<i>RGB green</i>
		31	<i>RGB blue</i>
	<i>HSV separate objects</i>	29	<i>HSV colour hue</i>
		30	<i>HSV saturation</i>
		3	<i>Dimming value (brightness)</i>
<i>RGBW colour control</i> (approaching a fixed value)	<i>RGBW 6 bytes</i>	19	<i>Colour control RGBW</i>
	<i>RGBW separate objects</i>	20	<i>RGB(W) red</i>
		21	<i>RGB(W) green</i>
		22	<i>RGB(W) blue</i>
		23	<i>White level</i>
	<i>HSVW separate objects</i>	20	<i>HSV(W) colour hue</i>
		21	<i>HSV(W) saturation</i>
		3	<i>Dimming value (brightness)</i>
		23	<i>White level</i>
	<i>RGBW colour change</i> (moving by a certain value)	<i>RGBW separate objects</i>	24
25			<i>RGB(W) green</i>
26			<i>RGB(W) blue</i>
27			<i>White level</i>
<i>HSVW separate objects</i>		24	<i>HSV(W) colour hue</i>
		25	<i>HSV(W) saturation</i>
		3	<i>Dimming value (brightness)</i>
		27	<i>White level</i>
<i>RGBW colour status</i> (send value on bus)	<i>RGBW 3 bytes</i>	28	<i>Colour status RGBW</i>
	<i>RGB separate objects</i>	29	<i>RGB(W) red</i>
		30	<i>RGB(W) green</i>
		31	<i>RGB(W) blue</i>
		32	<i>White level</i>
	<i>HSV separate objects</i>	29	<i>HSV(W) colour hue</i>
		30	<i>HSV(W) saturation</i>
		3	<i>Dimming value (brightness)</i>
		32	<i>White level</i>

### 5.3.3 Objects for the switching channel

**Object 41: Switch object, threshold as a percentage, threshold 0..255, threshold DPT 9.xxx, threshold 0..65535**

Input object: this object activates the set channel function (see parameter: *Channel function*).

The set channel function can either be activated via 1-bit telegram or by exceeding a threshold (8- or 16-bit telegram).

Parameters		Activation of channel function via
Activation of function via	Type of threshold object	
Switch object		1-bit telegram
Exceeding the threshold	Object type: Per cent (DPT5.001)	Exceeding percentage value
	Object type: Counter value 0..255 (DPT 5.010)	Any value in given numerical range
	Object type: Counter value 0..65535 (DPT 7.001)	
	Object type: EIS5 e.g. CO2, brightness (DPT 9.xxx)	2-byte floating-point number

**Object 42: Logic input in AND gate, in OR gate, in XOR gate**

Only available if operation is activated (**Configuration options** parameter page).

Forms a logical operation together with the input object to activate the channel function.

**Object 43: Block**

Blocks the channel function.

Response to the block being set and cancelled can be configured if the block function has been activated (**Configuration options** parameter page).

**Object 44: Call up/save scene**

Only available if the scene function has been activated (**Configuration options** parameter page).

This object can be used to save and subsequently call up scenes.

Saving stores the channel status.

The saved status is restored when it is called up.

All scene numbers from 1 to 64 are supported.

Each channel can participate in up to 8 scenes.

See appendix: [Scenes](#)

**Object 45: Block scenes = 1, enable scenes = 1**

Blocks the scene function with a 1 or a 0 depending on the configuration.

As long as it is blocked, scenes cannot be saved or called up.

**Object 46: Switching with priority**

Priority control:

Status of obj. <i>Switching with priority</i>	Channel status
0	as specified by the input object
1	
2	OFF
3	ON

#### *Object 47: On/Off feedback*

Reports the current channel status.

The status can also be inverted depending on configuration.

#### *Object 48: Time to next service, operating hours feedback*

Only available if the hour counter function is activated

(**Configuration options** parameter page).

Reports, depending on selected type of hour counter (**Operating hours counter and service** parameter page), either the remaining period to the next service or the current status of the hours counter.

#### *Object 49: Service required*

Only available if the hour counter function has been activated (**Configuration options** parameter page) and *Type of hour counter* = *Counter for time to next service*.

Reports if the next service is due.

0 = not due

1 = service is due.

#### *Object 50: Reset service, reset operating hours*

Function	Use
<i>Reset service</i> <sup>4</sup>	Reset service interval counter.
<i>Reset operating hours</i> <sup>5</sup>	Reset hour counter

---

<sup>4</sup> Depending on configuration

<sup>5</sup> Depending on configuration

## 5.3.4 Common objects

### Object 241: Set/reset Manual button

Manual mode can be set/reset via an object. The object value 0 also resets a temporary key lock, if configured.

### Object 242: Report Manual button

The status of the Manual mode can be read via a DPT 1.001 object.

### Object 243: Central permanent ON

Central switch-on function.

0 = no function

1 = permanent ON

Participation in this object can be set (**Configuration options** parameter page).



This object takes top priority.

As long as it is set, other switch commands will not work on the participating channel.

---

### Object 244: Central permanent OFF

Central switch-off function.

0 = no function

1 = permanent OFF

Participation in this object can be set (**Configuration options** parameter page).



This object has the second highest priority after Central permanent ON. As long as it is

set, other switch commands will not work on the participating channel.

---

### Object 245: Central switching

Central switch function.

0 = OFF

1 = ON

Participation in this object can be set (**Configuration options** parameter page).

With this object, the participating channel responds exactly as if its input object were receiving a switch command.

### Object 246: Call up/save central scenes

Central object for using scenes.

This object can be used to save and subsequently call up scenes.

See appendix: [\*Scenes\*](#)



### Object 247: Send firmware version

The version of the firmware can be queried via this DPT 217.001 object.

## 5.4 Parameter pages overview

### 5.4.1 General





Parameter page	Description
General	Activating channel buttons and Manual button.

Parameter page	Description
<i>General function block</i>	
General	Type of control and use of the switching channels
 <i>Channel C1..C4 Control</i>	
Configuration options	Characteristics of channel and activation of additional functions (colour control, soft switching, force, etc.).
Colour control <sup>6</sup>	Colour control depending on selected type of control, as well as other functions (colour value at permanent, response when switching on, etc.).
Dimming response	Dimming times, dimming switch-on value, etc.
Dimming value limitations	Scope of the limitation.
Soft switching	Brightness/dimming value, colour values and time settings for soft switching.
Block function	Type of block telegram and response to blocking.
Feedback	Format of the feedback objects and cyclical transmission time.
Force	Response in forced operation.
Scenes	Selection of scene numbers relevant to the channel.
Hour counter and service	Type of hour counter and, if applicable, service interval, etc.
Power failure and restoration	Response in the event of download a restoration of the bus supply.
 <i>Channel C1..C4 Relay</i>	
Configuration options	Characteristics of channel and activation of additional functions (scenes, operation, etc.).
Contact characteristics	Type of contact and status after download, bus failure, etc.
Threshold	Settings for triggering channel function through exceeding threshold.
Block function	Type of block telegram and response to blocking.
Scenes	Selection of scene numbers relevant to the channel.
Feedback	Status of feedback object, etc.
Hour counter and service	Type of hour counter and, if applicable, service interval, etc.
Operation	Selection of logical operation.

<sup>6</sup> Not available with *Type of control = Individual control*

## 5.5 General parameters

**i** The parameter Type of control must be set first of all, as it predetermines the configuration of all channels.

Type of control	C1		C2		C3		C4	
								
Individual control	✓	✓	✓	✓	✓	✓	✓	✓
Colour temperature	✓	✓	-	✓	✓	✓	✓	✓
Colour RGB	✓	✓	-	✓	-	✓	✓	✓
Colour RGBW	✓	✓	-	✓	-	✓	-	✓

✓ = available

- = Channel hidden: Output terminals are required for colour control by C1.

### 5.5.1 General parameter page

Designation	Values	Description
<i>Type of control</i>	<p><b>Individual control</b></p> <p><i>Colour temperature</i></p> <p><i>Colour RGB</i></p> <p><i>Colour RGBW</i></p>	<p>All channels are independent of each other. 4 control channels and up to 4 switching channels are available. No colour control.</p> <p>Control channels C1 and C2 are bundled. Configuration is made in channel C1. Output terminals: C1 = warm white C2 = cold white Channels C3 and C4 are freely available</p> <p>Control channels C1, C2 and C3 are bundled. Configuration is made in channel C1. Output terminals: C1 = red C2 = green C3 = blue Channel C4 is freely available</p> <p>All control channels are bundled (C1 to C4). Configuration is made in channel C1. Output terminals: C1 = red C2 = green C3 = blue C4 = white</p>
<i>Function of switching channel C1</i>	<b>Shut down control unit</b>	<p>The output relay works as a switch contact for the control channel. It switches depending on the dimming value: 0% = relay switched off &gt; 0% = relay switched on. Thus, the connected control unit (e.g. 0-10 V dimmer)</p>

Designation	Values	Description
		can be switched. In the ETS, the switching channel is hidden.
	<i>Switch actuator</i>	The switching channel is available as a switch actuator.
<i>Function of switching channel C2, C3, C4</i>	See C1	See C1
<i>Channel buttons</i>	<i>blocked</i>	No manual operation, the buttons on the device are blocked.
	<b><i>enabled</i></b>	The channels can be operated via the buttons on the device.
<i>Manual button</i>	<i>blocked</i>  <b><i>applies until reset via object</i></b>  <i>applies for 30 minutes or until reset via obj.</i>  <i>applies for 1 h or until reset via obj.</i>  <i>applies for 2 h or until reset via obj.</i>  <i>applies for 4 h or until reset via obj.</i>  <i>applies for 8 h or until reset via obj.</i>  <i>applies for 12 h or until reset via obj.</i>  <i>applies for 24 h or until reset via obj.</i>	The function of the Manual button can be blocked or enabled via the parameter.  An activated Manual applies for the selected time. After that, Manual will be automatically deactivated.  Bus telegrams are not processed in Manual mode. The objects received during Manual mode will also not be caught up.  After a bus failure, Manual mode will be reset.

## 5.6 Parameter for the control channel

### 5.6.1 Channel C1 Control: Configuration options

Designation	Values	Description
Adjust dimming value limitations	no	The standard values apply: Perform limitation when writing to object = no, Limitation applies to: - soft switching, - absolute dimming, - relative dimming, - switch command = no
	yes	The page <b>Dimming value limitations</b> will be shown and all parameters can be adjusted individually.
Adjust soft switching	no	The standard values apply: - Time for Soft ON = 1 min - Dimming value after Soft ON = 100% - Time between Soft ON and Soft OFF = 5 min - Dimming value after Soft OFF = 0% - Time for Soft OFF = 1 min
	yes	The page <b>Soft switching</b> will be shown and all parameters can be adjusted individually.
Adjust block function	no	The standard values apply: - Block with 1 (standard) - Response when the block is set = 10% - Response when cancelling the block = update





## 5.6.2 Colour control<sup>7</sup>

**i** The type of colour control is predetermined by the *Type of control* parameter on the **General** parameter page.  
See chapter [General parameters](#)

Designation	Values	Description
<i>Type of colour control</i> <sup>8</sup>	<i>Colour temperature</i> 1000 – 10000 K	Colour temperature
	<i>RGB (HVS) colour</i>	The colour can be selected directly via the Color Picker. The colour value is additionally displayed as a 6 byte hexadecimal value.
	<i>RGBW (HSVW) colour</i>	The colour can be selected directly via the Color Picker. The colour value is additionally displayed as a 6 byte hexadecimal value.
	<i>White level</i>	The white level is entered separately.
<i>Object type RGB(W)</i>	<b>With RGB colour</b>	
	<b>RGB combined</b>	1 RGB object 3 byte DPT232.600
	<i>RGB separate objects</i>	3 objects: red, green, blue.
	<i>HSV separate objects</i>	3 objects: Colour value (hue), colour saturation (saturation), light value (value).
	<b>With RGBW colour</b>	
	<b>RGB(W) combined</b>	1 RGBW object 6 byte DPT251.600
	<i>RGB(W) separate objects</i>	4 objects: red, green, blue, white level (white).
	<i>HSV(W) separate objects</i>	4 objects: Colour value (hue), colour saturation (saturation), bright value (value), white level (white).
<i>Colour at permanent</i>	<b>With RGB(W) colour</b>	
	<i>Colour value at Permanent RGB(W)</i> #000000 – #FFFFFF <b>#FF0000</b> <i>Additional white level Permanent (RGBW)</i> #00 ... #FF [ <b>#FF</b> ]	During Permanent ON and Force, the configured colour is set when colour control is activated
	<b>At colour temperature</b>	

<sup>7</sup> Not available with *Type of control = Individual control*

<sup>8</sup> This parameter is not adjustable and is only displayed here.

Designation	Values	Description
	<i>Colour temperature at Force/Permanent On</i> 1000 – 10000 K <b>3000 K</b>	This parameter can be used to set which colour temperature is to be used for Force and Permanent On.
<i>Response when switching on</i>	<b>Last object value</b>	The last object value is used. Note: If the object value is invalid, the preset colour of the ETS is used.
	<i>ETS parameters</i>	Use ETS parameters as set above
<i>Colour when switching on</i>	<b>At colour temperature</b>	
	<i>Colour temperature</i> 1000 – 10000 K <b>3000 K</b>	This parameter can be used to set which colour temperature is to be used when switching on.
	<b>With RGB(W)</b>	
	<i>Colour value when switching on RGB(W)</i> #000000 – #FFFFFF <b>#FF0000</b>	This parameter can be used to set which colour is to be used when switching on.
<i>Minimum colour temperature</i>	1000 K..5000 K <b>2000 K</b>	The minimum colour temperature is required for the calculation of the relative colour temperature.
<i>Maximum colour temperature</i>	5010 K..10000 K <b>6000 K</b>	Parameter for setting the maximum valid value for the colour temperature
<i>Time during colour change via dimming</i>	1 s, 2 s, 4 s 6 s, 8 s, <b>12 s</b> , 15 s, 24 s, 30 s, 60 s, 90 s	This parameter is used to decide how quickly the colour temperature should be changed when dimming.
<i>Time during colour change</i>	<b>immediately</b> 1 s, 2 s, 4 s 6 s, 8 s, 12 s, 15 s, 24 s, 30 s, 60 s, 90 s	This parameter is used to decide how quickly the colour temperature should be changed.

### 5.6.3 Dimming response

Designation	Values	Description
Minimum dimming value	1%, <b>5%</b> , 10%, 15%, 20%, 25%, 30% 35%, 40%, 45%, 50%	Minimum dimming value for all dimming processes (except 0%). Any values ( <i>switch-on dimming value, response to bus failure</i> etc.) which are below this threshold are increased to the <i>Minimum dimming value</i> .
Maximum dimming value	50%, 55%, 60%, 65%, 70%, 75%, 80%, 85%, 90%, 95%, <b>100%</b> ,	Maximum dimming value for all dimming processes. Any values ( <i>switch-on dimming value, response to bus failure</i> etc.) which are above this threshold will be lowered to the <i>maximum dimming value</i> .
Type of control channel	0-10 V  1-10 V	For 0-10 V control units.  For 1-10 V control units.
Output voltage at 0% <sup>9</sup>	<b>0 V</b> , 0.5 V, 1.0 V, 1.5 V 2.0 V, 2.5 V, 3.0 V, 3.5 V, 4.0 V, 4.5 V	Individual adjustment of the output voltage for special applications.
Output voltage at 100% <sup>10</sup>	5.5 V, 6.0 V, 6.5 V, 7.0 V, 7.5 V, 8.0 V 8.5 V, 9.0 V, 9.5 V, <b>10.0 V</b>	Individual adjustment of the output voltage for special applications.
Dimming time 1 from 0% to 100%	1 s, 2 s, <b>4 s</b> 6 s, 8 s, 12 s, 15 s, 24 s, 30 s, 60 s	This parameter defines the maximum dimming speed from 0 to 100% For greater flexibility, 3 different values can be specified (see below).
Dimming time 2 from 0% to 100%	1 s, 2 s, 4 s 6 s, <b>8 s</b> , 12 s, 15 s, 24 s, 30 s, 60 s	2nd pre-selectable dimming time.
Dimming time 3 from 0% to 100%	1 s, 2 s, 4 s 6 s, 8 s, <b>12 s</b> , 15 s, 24 s, 30 s, 60 s	3rd pre-selectable dimming time.
When receiving a switch command (1-bit)	<i>immediate on</i>  <b><i>soft on with dimming time 1</i></b> <i>soft on with dimming time 2</i> <i>soft on with dimming time 3</i>	The change from 0% to 100% or 100% to 0% takes place within max. 1 s.  The change from 0% to 100% or 100% to 0% takes place within the preset dimming time.
When receiving a dimming command (4-bit)	<i>immediate on</i>  <b><i>soft on with dimming time 1</i></b> <i>soft on with dimming time 2</i> <i>soft on with dimming time 3</i>	The change from 0% to 100% or 100% to 0% takes place within max. 1 s (in very quick increments), but can be interrupted by a stop command (release button).  The change from 0% to 100% or 100% to 0% takes place within the preset dimming time in correspondingly slower intermediate increments.

<sup>9</sup> Only if type of control channel = 0-10 V

<sup>10</sup> Only if type of control channel = 0-10 V

Designation	Values	Description
When receiving an absolute value (8-bit)	<i>immediate on</i>  <b>soft on with dimming time 1</b> <i>soft on with dimming time 2</i> <i>soft on with dimming time 3</i>	<p>The received dimming value is adopted immediately (max. delay 1 s).</p> <p>The change to the new dimming value takes place within the preset dimming time, proportionately to the change in value.            Example with dimming time 1 = 12 s:            Change from:            - 0 to 100% or 100 to 0% in 12 s (= 100% of 12 s)            - 25 to 50% or 50 to 25% in 3 s (= 25% of 12 s)            etc.</p>
Switch-on value	<b>Value before previous switch-off</b>  <i>minimum value</i>  10%, 20%, 30% 40%, 50%, 60% 70%, 80%, 90%, 100%	<p>The last dimming value before switching off is saved and restored.</p> <p>The configured minimum value is applied.</p> <p>The dimmer adopts the selected value after it is switched on.            Here again, the configured <i>Minimum dimming value</i> needs to be taken into account.</p>
Switch-on with 4-bit dim telegr.	         <i>no</i>  <b>yes</b>	<p>Defines the response if the channel is switched off and a 4-bit telegram (brighter) is received.            See appendix: <u>4-bit telegrams</u> (brighter / darker).</p> <p>Channel status remains unchanged.</p> <p>Channel is switched on and dimmed.</p>
Switching off with a 4-bit dim telegr.	         <i>no</i>  <i>yes</i>	<p>Defines the response if the channel is switched on and a 4-bit telegram (darker) is received.            See appendix: <u>4-bit telegrams</u> (brighter / darker).</p> <p>Channel status remains unchanged.</p> <p>Channel is switched off.</p>



## 5.6.4 Dimming value limitations

**i** The dimming value can be temporarily restricted via object *Dimming value limitation*. This is used, for example, to ensure that basic lighting is not exceeded at night, while during the evening the full range of lighting can be used.

Object description, see Object 9: Dimming value limitation.

Designation	Values	Description
<i>Perform limitation when writing to object</i>	<b>no</b>  <i>yes</i>	Limitation will not take effect until the next dimming process.  Limit the dimming value as soon as a value is received on the <i>Dimming value limitation</i> object.
<i>Limitation applies to switch command (1-bit)</i>	<b>no</b>  <i>yes</i>	No limitation during switch commands.  Limitation is effective.
<i>Limitation applies to relative dimming (4-bit)</i>	<b>no</b>  <i>yes</i>	No limitation during brighter / darker commands.  Limitation is effective.
<i>Limitation applies to absolute dimming (8-bit)</i>	<b>no</b>  <i>yes</i>	No limitation for percentage value telegrams.  Limitation is effective.
<i>Limitation applies to soft switching</i>	<b>no</b>  <i>yes</i>	No limitation for soft switching.  Limitation is effective.

## 5.6.5 Soft switching

Designation	Values	Description
Time for Soft ON	0 s, 1 s, 2 s, 4 s 6 s, 8 s, 12 s, 15 s 24 s, 30 s, 45 s, <b>1 min</b> 2 min, 3 min, 4 min, 5 min 6 min, 7 min, 8 min, 9 min 10 min, 12 min, 15 min, 20 min 30 min, 40 min, 50 min, 60 min	Duration of dim up phase (t1) for soft switching (see appendix). 0 s = switch on immediately.   For further details, see appendix : <u>Retriggering and premature switch off.</u>
Dimming value after Soft ON	10%, 20%, 30% 40%, 50%, 60%, 70%, 80%, 90%, <b>100%</b>	Final value at the end of Soft ON phase (Val) Comment: Here again, the configured <i>Minimum dimming value</i> needs to be taken into account.
Response colour value with Soft ON	<b>last object value</b>	Note: If the object value is invalid, the preset colour of the ETS is used.
	ETS parameters	Selected colour value or colour temperature for Soft ON.
Colour value <sup>11</sup> at Soft ON <sup>12</sup>	Colour temperature 1000 K..10000 K [ <b>3000 K</b> ]	This parameter can be used to set which colour temperature is to be used for Soft ON. Setting in increments of 10
	RGB(W) #000000 ... #FFFFFF [ <b>#FFFFFF</b> ] White level #00 ... #FF [ <b>#FF</b> ]	This parameter can be used to set which colour value is to be used for Soft ON.
Time between Soft ON and Soft OFF	until Soft OFF telegram  1 s, 2 s, 3 s, 4 s 5 s, 6 s, 7 s, 8 s, 9 s 10 s, 15 s, 20 s, 30 s 40 s, 50 s, 1 min, 2 min 3 min, 4 min, <b>5 min</b> , 6 min 7 min, 8 min, 9 min, 10 min 12 min, 15 min, 20 min, 30 min, 40 min, 50 min, 60 min	No time restriction; Soft OFF phase is initiated by a telegram.  Delay (t2) until the start of the Soft OFF phase.
Time for Soft OFF	0 s, 1 s, 2 s, 4 s 6 s, 8 s, 12 s, 15 s 24 s, 30 s, 45 s, <b>1 min</b> 2 min, 3 min, 4 min, 5 min 6 min, 7 min, 8 min, 9 min 10 min, 12 min, 15 min, 20 min, 30 min, 40 min, 50 min, 60 min	Duration of the Soft OFF phase (t3). 0 s = switch off immediately   For further details, see appendix : <u>Retriggering and premature switch off.</u>

<sup>11</sup> or colour temperature

<sup>12</sup> Only visible if Response colour value with Soft ON = ETS parameter

Designation	Values	Description
<i>Dimming value after Soft OFF</i>	<b>0%, 10%, 20%, 30%</b> 40%, 50%, 60%, 70%, 80%, 90%, 100%	Final value at the end of the Soft OFF phase (Val) Comment: Here again, the configured <i>minimum and maximum dimming value</i> needs to be taken into account.
<i>Response colour value with Soft OFF</i>	<b>last object value</b>  <i>ETS parameters</i>	Note: If the object value is invalid, the preset colour of the ETS is used.  Selected colour value or colour temperature for Soft OFF.
<i>Colour value<sup>13</sup> at Soft OFF<sup>14</sup></i>	<i>Colour temperature</i> 1000 K..10000 K [ <b>3000 K</b> ]	Colour temperature at Soft OFF. Setting in increments of 10
	<i>RGB(W)</i> #000000 ... #FFFFFF <b>[#FFFFFF]</b> <i>White level #00 ... #FF [<b>#FF</b>]</i>	RGB or RGBW colour value at Soft OFF.

<sup>13</sup> or colour temperature

<sup>14</sup> Only visible if *Response colour value with Soft OFF* = *ETS parameter*



## 5.6.6 Block function

Designation	Values	Description
Block telegram	<p><b>Block with 1 (standard)</b></p> <p><i>Block with 0</i></p>	<p>0 = cancel block 1 = block</p> <p>0 = block 1 = cancel block</p> <p> The block is always deactivated after reset.</p>
Response when setting the block	<p><i>no change</i></p> <p>100% 0%, <b>10%</b>, 20%, 30% 40%, 50%, 60%, 70%, 80%, 90%</p>	<p>No response.</p> <p>Dim to the set value.</p>
Response when the block is cancelled	<p><i>no change</i></p> <p><b>Update</b></p> <p>100%, 0%, 10%, 20%, 30%, 40%, 50%, 60%, 70%, 80%, 90%</p>	<p>No response.</p> <p>If a telegram was received during the block: Apply state. Otherwise: Restore state before the block.</p> <p>Dim to the set value.</p>

## 5.6.7 Feedback

Designation	Values	Description
<i>Format of 1-bit feedback</i>	<b><i>not inverted</i></b>  <i>inverted</i>	Standard setting: 1-100% = 1 0% = 0  1-100% = 0 0% = 1
<i>Send 1-bit feedback cyclically</i>	<i>no</i> <b><i>yes</i></b>	Send at regular intervals?
<i>Send 8-bit feedback</i>	<b><i>only after ending the dimming process</i></b>  <i>every 10%</i> <i>every 20%</i> <i>every 30%</i>	Only send current dimming value when the new dimming value has been reached.  Send even during the dimming process.
<i>Send 8-bit feedback cyclically</i>	<i>no</i> <b><i>yes</i></b>	Send at regular intervals?
<i>Time for cyclical transmission of feedback (if available)</i>	<i>2 min, 3 min, 5 min, 10 min, 15 min, 20 min, 30 min, 45 min, 60 min</i>	At what interval? This setting applies for both feedback objects (1 and 8-bit).

## 5.6.8 Force

Designation	Values	Description
<i>Format of force object</i>	<b>1 bit</b>  2 bit  1 byte (%)	Force is triggered by:  Switch telegram.  Priority telegram.  Dimming value.
1 bit		
<i>Activate force function with</i>	<b>1</b>  0	Recommended.  After reset/ download, forced operation is already activated and must be cancelled if necessary.
<i>Behaviour at start of force</i>	<b>no change</b> <i>minimum dimming value</i> 100%  OFF  10%, 20%, 30% 40%, 50%, 60% 70%, 80%, 90%	Response to the receipt of a force telegram. Here again, the configured <i>Minimum dimming value</i> needs to be taken into account.
<i>Behaviour at end of force</i>	update <sup>15</sup> <b>Value before force</b> <i>minimum dimming value</i> 100%  OFF  10%, 20%, 30% 40%, 50%, 60% 70%, 80%, 90%	Response to cancellation of force. Here again, the configured <i>Minimum dimming value</i> needs to be taken into account.
2 bit		
<i>Behaviour at force ON</i>	<b>no change</b> <i>minimum dimming value</i> 100%  OFF  10%, 20%, 30% 40%, 50%, 60% 70%, 80%, 90%	Response to the receipt of a force telegram. Here again, the configured <i>Minimum dimming value</i> needs to be taken into account.
<i>Behaviour at force OFF</i>	<b>OFF</b>	-
<i>Behaviour at end of force</i>	update <sup>16</sup> <b>Value before force</b>	Response to cancellation of force. Here again, the configured <i>Minimum dimming value</i> needs to be taken into

<sup>15</sup>4-bit commands received during the force (brighter/darker) will not be considered. Soft ON and Soft OFF processes will be aborted.

<sup>16</sup>4-bit commands received during the force (brighter/darker) will not be considered. Soft ON and Soft OFF processes will be aborted.

Designation	Values	Description
	<i>minimum dimming value</i>  100%  OFF  10%, 20%, 30% 40%, 50%, 60% 70%, 80%, 90%	account.
1 byte (%)		
<i>Behaviour at end of force</i>	<i>update</i> <sup>17</sup> <b>Value before force</b>  <i>minimum dimming value</i>  100%  OFF  10%, 20%, 30% 40%, 50%, 60% 70%, 80%, 90%	Response to cancellation of force. Here again, the configured <i>Minimum dimming value</i> needs to be taken into account.

---

<sup>17</sup>4-bit commands received during the force (brighter/darker) will not be considered. Soft ON and Soft OFF processes will be aborted.

## 5.6.9 Scenes

The dimming channel C1 can participate in up to 8 scenes.

Designation	Values	Description
<i>Block telegram for scenes</i>	<b>Block with 1 (standard)</b>  <i>Block with 0</i>	0 = cancel block 1 = block 0 = block 1 = cancel block Note: With this setting, the scenes are always blocked immediately after reset or download.
<i>All channel scene statuses</i>	<b>Overwrite on download</b>  <i>Unchanged after download</i>	A download deletes all scene memories of a channel, i.e. all previously taught-in scenes. When a scene number is called up, the channel assumes the configured assigned dimming value (see below). See in the appendix: <u><i>Entering scenes without telegrams</i></u>  All previously taught-in scenes are saved. However, the scene numbers to which the channel should react can be changed (see below: Channel reacts to).
<i>Participation in central scene object</i>	<b>No</b> <i>yes</i>	Should the device react to the central scene object?
<i>Channel reacts to</i>	<i>No scene number</i> <b>Scene number 1</b>  <i>Scene number 63</i>	First of the 8 possible scene numbers to which the channel is to react.
<i>Assigned dimming value</i>	<i>Off</i> <b>10%, 20%, 30%</b> <i>40%, 50%, 60%, 70%, 80%, 90%, 100%</i>	New dimming value to be assigned to the selected scene number.  Only possible if the scene statuses are to be overwritten after download.
<i>Behaviour when receiving the scene number</i>	<i>immediate on</i>	Output dimming value without delay.
	<i>soft on at dimming speed</i> <b>1</b> <i>soft on at dimming speed</i> <b>2</b> <i>soft on at dimming speed</i> <b>3</b>	Slowly reach the dimming value with the specified delay.
<i>Permit teach-in</i>	<i>No</i>	Scenes can only be called up.
	<b>Yes</b>	The user can both call up and teach in or amend scenes.

Designation	Values	Description
<i>Colour value</i>	<b>RGB</b> RGBW Colour temperature	When colour control is activated, a colour value can be assigned to the selected scene number. The parameter Type of colour control defines which values are available.
<i>Channel reacts to</i>	<i>No scene number</i> <i>Scene number 1</i> <b><i>Scene number 2</i></b> ... <i>Scene number 63</i>	Second of the 8 possible scene numbers.
<i>Assigned dimming value</i>	See above	See above
<i>Behaviour when receiving the scene number</i>	See above	See above
<i>Permit teach-in</i>	See above	See above
<i>Colour value</i>	See above	See above
<i>Channel reacts to</i>	<i>No scene number</i> <i>Scene number 1</i> ... <b><i>Scene number 3</i></b> ... <i>Scene number 63</i>	Third of the 8 possible scene numbers.
<i>Assigned dimming value</i>	See above	See above
<i>Behaviour when receiving the scene number</i>	See above	See above
<i>Permit teach-in</i>	See above	See above
<i>Colour value</i>	See above	See above
<i>Channel reacts to</i>	<i>No scene number</i> <i>Scene number 1</i> ... <b><i>Scene number 4</i></b> ... <i>Scene number 63</i>	Fourth of the 8 possible scene numbers.
<i>Assigned dimming value</i>	See above	See above
<i>Behaviour when receiving the scene number</i>	See above	See above
<i>Permit teach-in</i>	See above	See above
<i>Colour value</i>	See above	See above
<i>Channel reacts to</i>	<i>No scene number</i> <i>Scene number 1</i> ... <b><i>Scene number 5</i></b> ... <i>Scene number 63</i>	Fifth of the 8 possible scene numbers.
<i>Assigned dimming value</i>	See above	See above
<i>Behaviour when receiving the scene number</i>	See above	See above

Designation	Values	Description
<i>Permit teach-in</i>	See above	See above
<i>Colour value</i>	See above	See above
<i>Channel reacts to</i>	No scene number Scene number 1 ... <b>Scene number 6</b> ... Scene number 63	Sixth of the 8 possible scene numbers.
<i>Assigned dimming value</i>	See above	See above
<i>Behaviour when receiving the scene number</i>	See above	See above
<i>Permit teach-in</i>	See above	See above
<i>Colour value</i>	See above	See above
<i>Channel reacts to</i>	No scene number Scene number 1 ... <b>Scene number 7</b> ... Scene number 63	Seventh of the 8 possible scene numbers.
<i>Assigned dimming value</i>	See above	See above
<i>Behaviour when receiving the scene number</i>	See above	See above
<i>Permit teach-in</i>	See above	See above
<i>Colour value</i>	<b>RGB</b> RGBW Colour temperature	See above
<i>Channel reacts to</i>	No scene number Scene number 1 ... <b>Scene number 8</b> ... Scene number 63	Last of the 8 possible scene numbers.
<i>Assigned dimming value</i>	See above	See above
<i>Behaviour when receiving the scene number</i>	See above	See above
<i>Permit teach-in</i>	See above	See above
<i>Colour value</i>	See above	See above

### 5.6.10 Hour counter and service

Designation	Values	Description
<i>Type of hour counter</i>	<b>Hour counter</b>	Forward counter for channel duty cycle.
	<i>Counter for time to next service</i>	Backward counter for channel duty cycle.
<b>Hour counter</b>		
<i>Reporting operating hours in the event of a change (0..100 h, 0 = do not report)</i>	0..100 Standard = 10	At what interval is the current counter reading to be sent? <b>Example:</b> 10 = Send each time the counter reading increases by another 10 hours.
<i>Report operating hours cyclically</i>	No yes	Send at regular intervals?
<i>Time for cyclical transmission</i>	2 minutes, 3 minutes, 5 minutes, 10 minutes, 15 minutes, 20 minutes, 30 minutes, 45 minutes 60 minutes	At what interval?
<b>Counter for time to next service</b>		
<i>Service interval (x10 h)</i>	0..2000 Standard = 100	Desired time between 2 services. <b>Example:</b> 10 = 10 x 10 h = 100 hours
<i>Reporting of time to service in the event of a change (0 = do not report)</i>	0..100 Standard = 10	At what interval is the current counter reading to be sent? <b>Example:</b> 10 = Send each time the counter reading decreases by another 10 hours.
<i>Report time to service cyclically</i>	no Yes	Send remaining time to next service at regular intervals? → Object Time to next service.
<i>Report service cyclically</i>	no Yes	Send expiry of time to next service at regular intervals? → Object Service required.
<i>Time for cyclical transmission (if used)</i>	2 minutes, 3 minutes, 5 minutes, 10 minutes, 15 minutes, 20 minutes, 30 minutes, 45 minutes 60 minutes	At what interval?



## 5.6.11 Power failure and restoration

Designation	Values	Description
<i>Dimming value during download</i>	<b><i>same as before failure</i></b>	Restore status before download or maintain status before bus failure.
<i>Dimming value during restoration of the bus supply</i>	<b><i>same as before failure</i></b> <i>100%, 0%, 10%, 20%, 30% 40%, 50%, 60% 70%, 80%, 90%</i>	Restore status before failure.  Apply set value here. Here again the configured minimum dimming value needs to be taken into account.

---

 The colour value for permanent is used as the colour

---



Designation	Values	Description
	<i>in central switching, permanent ON, permanent OFF</i> <i>only in central permanent ON</i> <i>only in central permanent OFF</i> <i>only in central switching</i> <i>only in central switching and permanent ON</i> <i>only in central switching and permanent OFF</i> <i>only in central permanent ON and permanent OFF</i>	<p>Which central objects are to be taken into account?</p> <p>Central objects enable simultaneous switching on and off of several channels with one single object.</p>
<i>Adjust feedback</i>	<p>Yes..</p> <p><b>no</b></p>	<p>The feedback function can be individually adjusted. The relevant parameter page is shown.</p> <p>The <i>Feedback</i> function works with the standard parameters:</p> <ul style="list-style-type: none"> <li>- <i>not inverted</i></li> <li>- <i>do not send cyclically</i></li> </ul>
<i>Activate hour counter</i>	<p>Yes..</p> <p><b>no</b></p>	<p>Is the hour counter /service interval function to be used?</p>
<i>Activate operation</i>	<p>Yes..</p> <p><b>no</b></p>	<p>Use logical operations with the channel object?</p>

## 5.7.2 Contact characteristics

Designation	Values	Description
<i>Type of contact</i>	<b>NO contact</b>  <i>Opening contact</i>	Standard: The relay contact is closed when a switch-on command is issued.  Inverted: The relay contact is opened when a switch-on command is issued.
<i>Status during download</i>	<i>OFF</i>  <i>ON</i>  <b>unchanged</b>	After download or during bus voltage failure... ..the relay switches off.  ..the relay switches on.  ...the relay remains in the same state as before.  <hr/> <b>i</b> If several switching operations were executed immediately before bus failure, the energy may not be sufficient for an additional switching operation. In this case, the relay remains in its previous state, regardless of the parameter setting. <hr/>
<i>Status with restoration of the bus supply</i>	<i>OFF</i>  <i>ON</i>  <b>same as before failure</b>	After restoration of bus voltage... ..the relay is switched off.  ..the relay switches on.  ...the relay remains in the same state as before.

## 5.7.3 The "On/off delay.." time function

This parameter page appears if *On/off delay* is selected as the *Channel function*.

Designation	Values	Description
<i>Switch-on delay</i>		
<i>Hours</i>	<i>0..3</i>	Input of desired switch-on delay in hours.
<i>Minutes</i>	<i>0..60</i>	Input of desired switch-on delay in minutes.
<i>Seconds</i>	<i>0..255</i>	Input of desired switch-on delay in seconds.
<i>Switch-off delay</i>		
<i>Hours</i>	<i>0..3</i>	Input of desired switch-off delay in hours.
<i>Minutes</i>	<i>0..60</i>	Input of desired switch-off delay in minutes.
<i>Seconds</i>	<i>0..255</i>	Input of desired switch-off delay in seconds.

## 5.7.4 The "Pulse" time function

This parameter page appears if *Pulse function* is selected as the *Channel function*.

Designation	Values	Description
<i>Hours</i>	<b>0..3</b>	Input of desired pulse duration in hours.
<i>Minutes</i>	<b>0..60</b>	Input of desired pulse duration in minutes.
<i>Seconds</i>	<b>0..255</b>	Input of desired pulse duration in seconds.
<i>Pulse retriggerable (with 1 on switch object)</i>	<b>Yes</b>	The pulse can be extended as often as desired via a 1-telegram
	<b>No</b>	The pulse cannot be extended.
<i>Pulse resettable (with 1 on switch object)</i>	<b>Yes</b>	The pulse can be ended prematurely at any time via a 0-telegram.
	<b>No</b>	The pulse cannot be ended prematurely

## 5.7.5 The "Staircase light with forewarning function .." time function

This parameter page appears if *Staircase light with forewarning function* is selected as the *Channel function*.

The user can press a push button again to extend the staircase light time at any time.

Designation	Values	Description
<i>Staircase light time (min. 1 s)</i>		
<i>Hours</i>	<b>0..3</b>	Input of desired switch-on delay in hours.
<i>Minutes</i>	<b>0..60</b>	Input of desired switch-on delay in minutes.
<i>Seconds</i>	<b>0..255</b>	Input of desired switch-on delay in seconds.
<i>The maximum sum of pulses</i>	<b>1..40</b> <i>Default value = 5</i>	Determines how often the staircase light time can be extended (restarted) by pressing the button again.
<i>Duration of 1st Forewarning in s</i>	<b>0</b>  <b>1..60</b> <i>Default value = 10</i>	The light switches off immediately once the staircase light time is completed.  Once the staircase light time has expired, the light should flash briefly and then stay on for the duration of the forewarning
<i>Duration of 2nd Forewarning in s</i>	<b>0</b>  <b>1..60</b> <i>Default value = 30</i>	No 2nd forewarning. At the end of the 1st Forewarning, the light will be switched off.  Second forewarning: After expiration of the 1st forewarning, the light should flash briefly and then stay on for the duration of the 2nd forewarning After this time, the light will be switched off.

### Example: forewarning function



### 5.7.6 The "Flashing" time function

This parameter page appears if *Flashing* is selected as the *Channel function* .

Designation	Values	Description
ON phase of flash pulse		
<i>Hours</i>	<b>0..3</b>	Input of desired pulse time in hours.
<i>Minutes</i>	<b>0..60</b>	Input of desired pulse time in minutes.
<i>Seconds</i>	<b>0..255</b>	Input of desired pulse time in seconds.
OFF phase of flash pulse		
<i>Hours</i>	<b>0..3</b>	Input of desired length of break in hours.
<i>Minutes</i>	<b>0..60</b>	Input of desired length of break in minutes.
<i>Seconds</i>	<b>0..255</b>	Input of desired length of break in seconds.
<i>How often should it flash</i>	<i>Until it switches off</i>  1 x 2 x <b>3 x</b> 4 x 5 x 7 x 10 x 15 x 20 x 30 x 50 x	The channel flashes until a switch-off telegram is received.  The channel flashes as often as set here.



### 5.7.7 Threshold

This page is shown if the *Activation of the function by exceeding threshold* parameter is set.

Designation	Values	Description
<i>Type of threshold object</i>	<b>Per cent (DPT5.001)</b> Counter value 0..255 (DPT 5.010) Counter value 0..65535 (DPT 7.001) Floating-point number (DPT9), e.g. temperature, brightness, etc.	Threshold format
Parameter for threshold object <i>Per cent</i>		
<i>Threshold</i>	1..99% Default value = 50%	Desired threshold. Example of NO contact with response as switch object = 1: Switches on when: Object value > threshold value Switches off when: Object value < threshold value - hysteresis
<i>Hysteresis (in %)</i>	1..99% Default value = 10%	The hysteresis prevents frequent switching after small fluctuations in readings.
Parameter for threshold object <i>Counter value 0..255</i>		
<i>Threshold</i>	1..254 Default value = 127	Desired threshold. Example of NO contact with response as switch object = 1: Switches on when: Object value > threshold value Switches off when: Object value < threshold value - hysteresis
<i>Hysteresis</i>	1..254 Default value = 5	The hysteresis prevents frequent switching after small fluctuations in readings.
Parameter for threshold object <i>Counter value 0..65535</i>		
<i>Threshold</i>	1..65534 Default value = 1000	Desired threshold. Example of NO contact with response as switch object = 1: Switches on when: Object value > threshold value Switches off when: Object value < threshold value - hysteresis
<i>Hysteresis</i>	1..65534 Default value = 5	The hysteresis prevents frequent switching after small fluctuations in readings.
Parameter for threshold object <i>Floating-point number (DPT9), e.g. temperature, brightness, etc.)</i>		
<i>Threshold</i>	-671088.64.. 670760.96 Default value = 20	Desired threshold. Example of NO contact with response as switch object = 1: Switches on when: Object value > threshold value Switches off when: Object value < threshold value - hysteresis
<i>Hysteresis</i>	0.01..	The hysteresis prevents frequent switching

Designation	Values	Description
	670760.96 Default value = 1	after small fluctuations in readings.
<i>Response on exceeding the threshold</i>	<p><i>As switch object = 0</i></p> <p><i>As switch object = 1</i></p>	<p>Should the channel switch on or off on exceeding the threshold? The set type of contact must be taken into account here.</p> <p>NO contact: the relay switches off when exceeding. Opening contact: the relay switches on when exceeding.</p> <p>NO contact: the relay switches on when exceeding. Opening contact: the relay switches off when exceeding.</p>

## 5.7.8 Block function

This page appears when "Adjust block function" is selected on the **Configuration options** parameter page.

Designation	Values	Description
<i>Block telegram</i>	<b><i>Block with 1 (standard)</i></b>	0 = Cancel block 1 = block
	<i>Block with 0</i>	0 = block 1 = cancel block  Note: The block is always deactivated after reset.
<i>Response when setting the block</i>	<i>OFF</i>	Switch off
	<i>ON</i>	Switch on
	<b><i>unchanged</i></b>	No response
<i>Response when the block is cancelled</i>	<i>OFF</i>	Switch off
	<i>ON</i>	Switch on
	<i>Unchanged</i>	No response
	<b><i>update</i></b>	Restore normal operation and switch relay accordingly.



Designation	Values	Description
	<b>Yes</b>	
<b>Channel reacts to</b>		
<i>Channel reacts to</i>	<i>No scene number</i> <i>Scene number 1</i> ... <b><i>Scene number 3</i></b> ... <i>Scene number 63</i>	Third of the 8 possible scene numbers
<i>Status after download</i>	<b><i>Off</i></b> <i>On</i>	See above.
<i>Permit teach-in</i>	<i>No</i> <b><i>Yes</i></b>	See above.
<b>Channel reacts to</b>		
<i>Channel reacts to</i>	<i>No scene number</i> <i>Scene number 1</i> ... <b><i>Scene number 4</i></b> ... <i>Scene number 63</i>	Fourth of the 8 possible scene numbers
<i>Status after download</i>	<b><i>Off</i></b> <i>On</i>	See above.
<i>Permit teach-in</i>	<i>No</i> <b><i>Yes</i></b>	See above.
<b>Channel reacts to</b>		
<i>Channel reacts to</i>	<i>No scene number</i> <i>Scene number 1</i> ... <b><i>Scene number 5</i></b> ... <i>Scene number 63</i>	Fifth of the 8 possible scene numbers
<i>Status after download</i>	<b><i>Off</i></b> <i>On</i>	See above.
<i>Permit teach-in</i>	<i>No</i> <b><i>Yes</i></b>	See above.
<b>Channel reacts to</b>		
<i>Channel reacts to</i>	<i>No scene number</i> <i>Scene number 1</i> ... <b><i>Scene number 6</i></b> ... <i>Scene number 63</i>	Sixth of the 8 possible scene numbers
<i>Status after download</i>	<b><i>Off</i></b> <i>On</i>	See above.
<i>Permit teach-in</i>	<i>No</i> <b><i>Yes</i></b>	See above.
<b>Channel reacts to</b>		
<i>Channel reacts to</i>	<i>No scene number</i> <i>Scene number 1</i> ... <b><i>Scene number 7</i></b> ... <i>Scene number 63</i>	Seventh of the 8 possible scene numbers
<i>Status after download</i>	<b><i>Off</i></b> <i>On</i>	See above.
<i>Permit teach-in</i>	<i>No</i> <b><i>Yes</i></b>	See above.

Designation	Values	Description
<i>Channel reacts to</i>	<i>No scene number</i> <i>Scene number 1</i> ... <b><i>Scene number 8</i></b> ... <i>Scene number 63</i>	Last of the 8 possible scene numbers
<i>Status after download</i>	<b><i>Off</i></b> <i>On</i>	See above.
<i>Permit teach-in</i>	<i>No</i> <b><i>Yes</i></b>	See above.

## 5.7.10 Feedback

Designation	Values	Description
<i>Reported status</i>	<b><i>Not inverted</i></b>  <i>inverted</i>	Channel switched on: feedback object sends a 1  Channel switched on: feedback object sends a 0
<i>Send feedback cyclically</i>	<b>No</b> <i>Yes</i>	Send at regular intervals?
<i>Time for cyclical transmission of feedback</i>	<i>2 minutes, 3 minutes, 5 minutes, 10 minutes, 15 minutes, 20 minutes, 30 minutes, 45 minutes 60 minutes</i>	At what interval?

### 5.7.11 Hour counter and service

This page appears when *Activate hour counter* is selected on the **Configuration options** parameter page.

Designation	Values	Description
<i>Type of hour counter</i>	<b>Hour counter</b>	Forward counter for channel duty cycle.
	<i>Counter for time to next service</i>	Backward counter for channel duty cycle.
<i>Hour counter</i>		
<i>Reporting operating hours in the event of a change (0..100 h, 0 = do not report)</i>	0..100 Standard = 10	At what interval is the current counter reading to be sent? Example: 10 = Send each time the counter reading increases by another 10 hours.
<i>Report operating hours cyclically</i>	<b>No</b> yes	Send at regular intervals?
<i>Time for cyclical transmission</i>	2 minutes, 3 minutes, 5 minutes, 10 minutes, 15 minutes, 20 minutes, 30 minutes, 45 minutes <b>60 minutes</b>	At what interval?
<i>Counter for time to next service</i>		
<i>Service interval (x10 h)</i>	0..2000 Standard = 100	Desired time between 2 services. Example: 10 = 10 x 10 h = 100 hours
<i>Reporting of time to service in the event of a change (0 = do not report)</i>	0..100 Standard = 10	At what interval is the current counter reading to be sent? Example: 10 = Send each time the counter reading decreases by another 10 hours.
<i>Report time to service cyclically</i>	<b>no</b> Yes	Send <b>remaining</b> time to next service at regular intervals? → Object <i>Time to next service</i> .
<i>Report service cyclically</i>	<b>no</b> Yes	Send <b>Expiration</b> of time to next service at regular intervals? → Object <i>Service required</i> .
<i>Time for cyclical transmission (if used)</i>	2 minutes, 3 minutes, 5 minutes, 10 minutes, 15 minutes, 20 minutes, 30 minutes, 45 minutes <b>60 minutes</b>	At what interval?

### 5.7.12 Operation

Designation	Values	Description
<i>Activate operation</i>		Selection of logical operation with the channel object



Designation	Values	Description
	<p><b>AND operation</b></p> <p><i>OR operation (override)</i></p> <p><i>XOR operation</i></p>	<p>The <i>Logic input in AND gate</i> object appears.</p> <p>The <i>Logic input in OR gate</i> object appears.</p> <p>The <i>Logic input in XOR gate</i> object appears.</p>
<i>Block object affects logic object</i>	<p><b>No</b></p> <p><i>yes</i></p>	<p>The block object only affects the input object. If required, the logic object can activate the channel function despite block (with OR and XOR operation).</p> <p>The block object affects the input object and the logic object. The channel function is completely blocked if the block is active.</p>



## 6 Application examples

### 6.1 1-10 V lighting control

In passage areas, the lighting should be automatically controlled depending on motion and daylight. The lighting can be dimmed steplessly over 1-10 V and is controlled automatically via presence detectors.

The connected 1-10 V control units are automatically switched on and off via the relay contact.

*Type of control = individual control*

Channel	C1	C2	C3	C4
	separate	separate	separate	separate
	internal with control channel	internal with control channel	internal with control channel	internal with control channel

#### 6.1.1 Devices:

- SM 4 KNX (4940310)
- thePassa P360 KNX UP WH (2019300)

#### 6.1.2 Overview

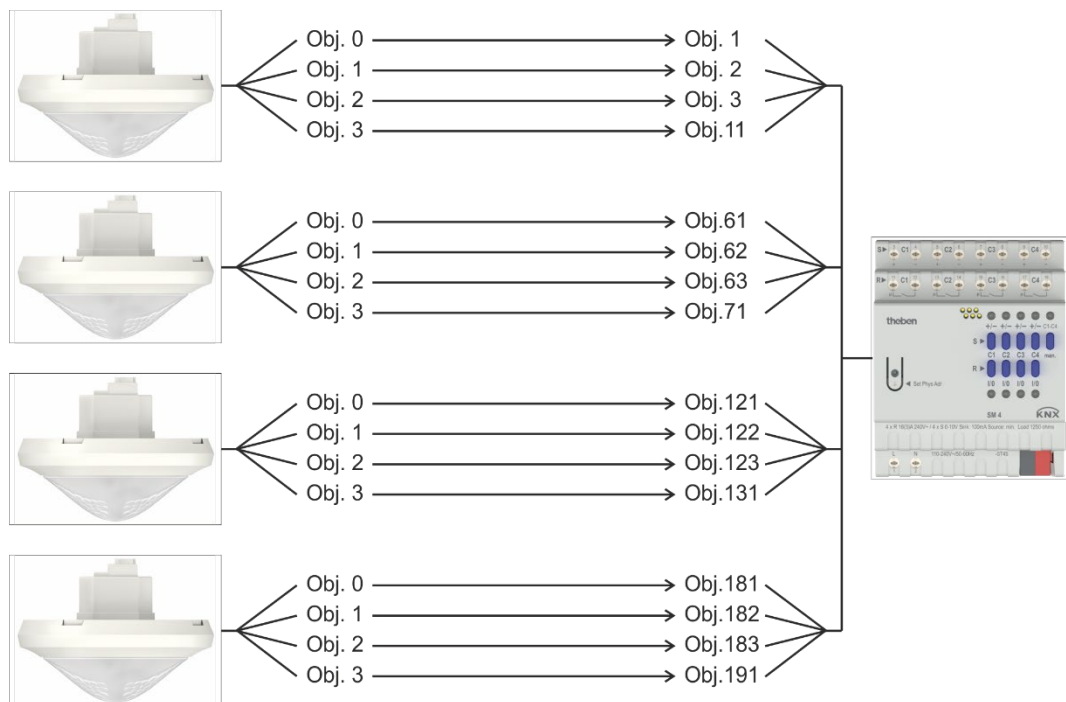

## 6.1.3 Objects and links

No.	1. thePassa P360 KNX Object name	No.	SM 4 KNX C1 Control Object name	
0	Channel C1 Switching	1	Switching On/Off	Switch telegram
1	Channel C1 Brighter/darker	2	brighter/darker	Dimming up or down
2	Channel C1 Send value	3	Dimming value	Dimming telegram
3	Channel C1 Feedback value	11	Feedback in %	Feedback
	<b>2. thePassa P360 KNX</b>		<b>SM 4 KNX C2 Control</b>	
0	Channel C1 Switching	61	Switching On/Off	Switch telegram
1	Channel C1 Brighter/darker	62	brighter/darker	Dimming up or down
2	Channel C1 Send value	63	Dimming value	Dimming telegram
3	Channel C1 Feedback value	71	Feedback in %	Feedback
	<b>3. thePassa P360 KNX</b>		<b>SM 4 KNX C3 Control</b>	
0	Channel C1 Switching	121	Switching On/Off	Switch telegram
1	Channel C1 Brighter/darker	122	brighter/darker	Dimming up or down
2	Channel C1 Send value	123	Dimming value	Dimming telegram
3	Channel C1 Feedback value	131	Feedback in %	Feedback
	<b>4. thePassa P360 KNX</b>		<b>SM 4 KNX C4 Control</b>	
0	Channel C1 Switching	181	Switching On/Off	Switch telegram
1	Channel C1 Brighter/darker	182	brighter/darker	Dimming up or down
2	Channel C1 Send value	183	Dimming value	Dimming telegram
3	Channel C1 Feedback value	191	Feedback in %	Feedback

## 6.1.4 Important parameter settings

Standard or customer-defined parameter settings apply to unlisted parameters.

SM 4

Parameter page	Parameters	Setting
General	Type of control	Individual control
	Function of switching channel C1	Shut down control unit
	Function of switching channel C2	Shut down control unit
	Function of switching channel C3	Shut down control unit
	Function of switching channel C4	Shut down control unit

thePassa P360 KNX UP WH

Parameter page	Parameters	Setting
General	Operating mode	Master
	Function of channel C1 Light	Constant lighting control

## 6.2 Colour temperature control 0-10 V

The lighting is to be controlled automatically via presence detectors depending on presence and the amount of daylight. The presence detector also provides current measurement values for the CO2 value and relative humidity in the room.



The lighting is to be dimmed and switched manually via tactile sensor, while the colour temperature can also be adjusted. The colour temperature has an influence on human well-being and can be stimulating (high colour temperature/cold light) or calming (low colour temperature/warm light).

For colour temperature control, the channels "S" C1 + C2 are used. Channel "R" C1 switches the power unit of the colour temperature control.

Channel "R" C2 is available as a separate switching channel for individual applications.

Channels "S" C3 and C4, as well as the channels "R" C3, C4 are used for individual control and switching of further consumers. These channels are not part of this application example.

### Type of control = colour temperature

Channel	C1	C2	C3	C4
	CW Cold white	WW Warm white	separate	separate
	internal with control channel	Separate switching channel	Internal with control channel OR as a separate switching channel	Internal with control channel OR as a separate switching channel

### 6.2.1 Devices

- SM 4 KNX (4940310) thePrema P360 KNX AP Multi WH (2079900), consisting of presence detector KNX and room air sensor AMUN 716 S KNX
- iON 104 KNX (4969234)

### 6.2.2 Overview

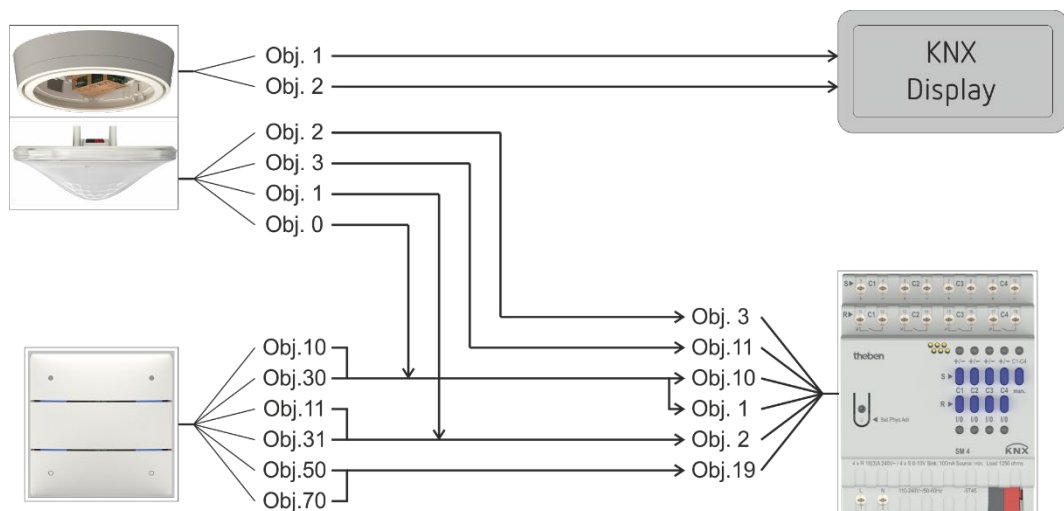

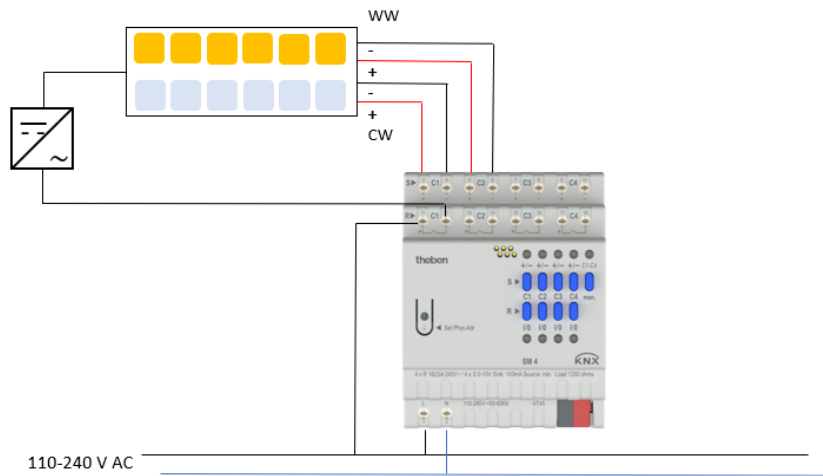

## 6.2.3 Objects and links

No.	iON 104	No.	SM 4 KNX	Comment
	Object name		Object name	
10	Button T1 Switching	1	Channel C1 Switching	Switching light on/off
		10	Channel C1 Feedback On/Off	Report status
11	Button T1 Brighter	2	Channel C1 Brighter/darker	Dimming light brighter
30	Button T2 Switching	1	Channel C1 Switching	Switching light on/off
		10	Channel C1 Feedback On/Off	Report status
31	Button T2 Darker	2	Channel C1 Brighter/darker	Dimming light darker
50	Button 3.1 send colour temperature	19	Channel C1 Colour temperature	Low (warm) colour temperature
70	Button 4.1 send colour temperature	19	Channel C1 Colour temperature	High (cold) colour temperature

No.	thePrema P360 KNX	No.	SM 4 KNX	Comment
	Object name		Object name	
0	Channel C1 Switching	1	Channel C1 Switching	Switching light on/off
1	Channel C1 Brighter/darker	2	Channel C1 Brighter/darker	Dimming light
2	Channel C1 Send value	3	Channel C1 Dimming value	Set dimming value (%)
3	Channel C1 Feedback value	11	Channel C1 Feedback %	Report dimming value (%)

No.	AMUN 716 S KNX	No.	KNX visualisation	Comment
	Object name		Object name	
1	Send CO2 value	-	(device-dependent)	Current measurement value for visualisation
2	Send relative humidity	-	(device-dependent)	Current measurement value for visualisation

## 6.2.4 Important parameter settings

Standard or customer-defined parameter settings apply to unlisted parameters

### SM 4 KNX

Parameter page	Parameters	Setting
General	Type of control	Colour temperature
	Function of switching channel C1	Shut down control unit
	Function of switching channel C2	Switch actuator
	Function of switching channel C3	any
	Function of switching channel C4	any

### thePrema P360 KNX

Parameter page	Parameters	Setting
General	Function channel C1 Light	Constant lighting control

### iON 104 KNX

Parameter page	Parameters	Setting
General		
Settings	Device type	iON 104 KNX
Button T1		
Configuration options	Function	Dimming
Dimming	Response to long/short	brighter/change over
Button T2		
Configuration options	Function	Dimming
Dimming	Response to long/short	darker/change over
Button T3		
Push button object 1	Object type	Colour temperature DPT7.600 (2 byte)
Button T4		
Push button object 1	Object type	Colour temperature DPT7.600 (2 byte)





## 6.3 Colour control RGBW (0-10 V)

An LED lighting is to be controlled in brightness and colour. The control is effected over 0-10 V. The lighting is to be dimmed and switched manually via a tactile sensor, while also 12 predefined colours can be set.

For RGBW colour control, the channels "S" C1 (red), C2 (green), C3 (blue) and C4 (white) are used. Channel "R" C1 switches the power unit of the colour control.

Channels "R" C2, C3, C4 are used for individual switching of further consumers. These channels are not part of this application example.

### Type of control = colour RGBW

Channel	C1	C2	C3	C4
	R	G	B	W
	internal with control channel	Separate switching channel	Separate switching channel	Separate switching channel

### 6.3.1 Devices

- SM 4 KNX (4940310)
- iON 108 KNX (4969238)

### 6.3.2 Overview

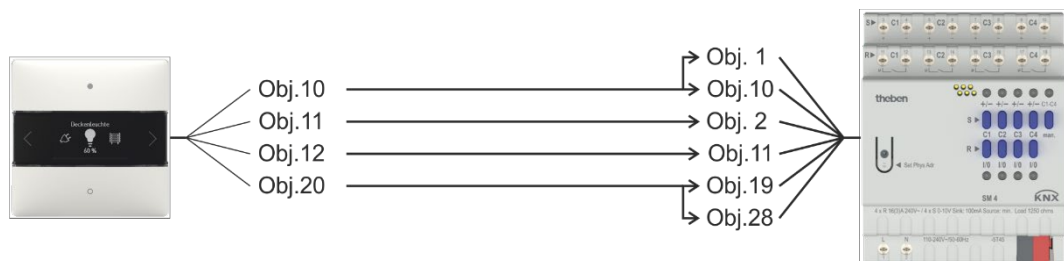

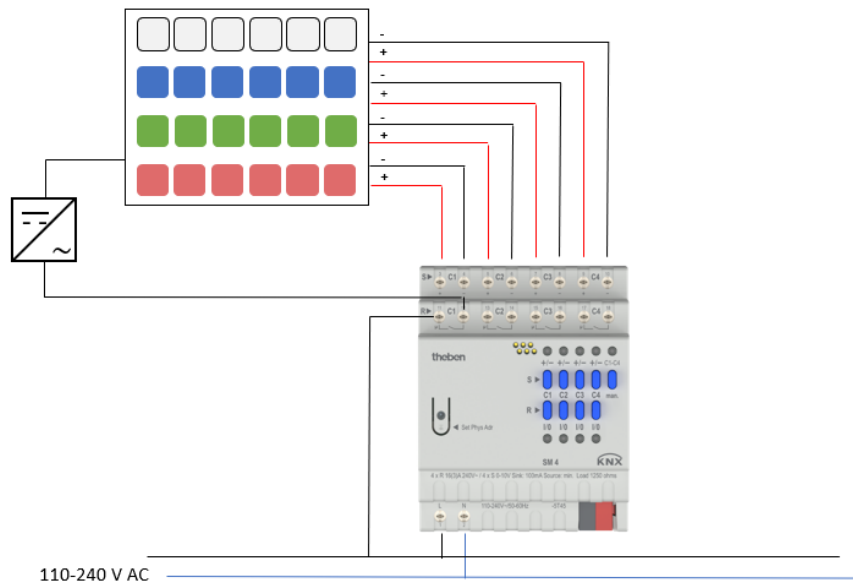

### 6.3.3 Objects and links

No.	iON 108 Object name	No.	SM 4 KNX Object name	Comment
10	F1 switching	1	Channel C1 Switching	Switching light on/off
		10	Channel C1 Feedback On/Off	Report status
11	F1 Brighter/darker	2	Channel C1 Brighter/darker	Dimming light brighter
12	F1 Dimming value feedback %	11	Channel C1 Feedback in %	Report status
20	F2 RGBW value	19	Channel C1 Colour control RGBW	Set colour
		28	Channel C1 Colour status RGBW	Report current colour

## 6.3.4 Important parameter settings

Standard or customer-defined parameter settings apply to unlisted parameters

SM 4 KNX

Parameter page	Parameters	Setting
General	Type of control	Colour RGBW
	Function of switching channel C1	Shut down control unit
	Function of switching channel C2	Switch actuator
	Function of switching channel C3	Switch actuator
	Function of switching channel C4	Switch actuator

iON 108 KNX

Parameter page	Parameters	Setting
Function F1		
Configuration options	Function	Dimming
	Response to long/short	Brighter at top/change over Darker at bottom/change over
Function F2		
Configuration options	Function	RGBW colour value
	Mode of operation	Value list
Value list	Length of list	12

## 7 Appendix

### 7.1 Priorities

Dimming values and commands are processed in blocks. Each block processes the commands of previous blocks and makes changes if necessary. The result is forwarded to the subsequent block. Blocks with higher priority can thus block the commands of blocks with lower priority.

#### **Switching**

The objects of the Switching block have the lowest priority. A new object overwrites the switching status of previous objects. All objects are equal.

#### **Block**

During a block, the objects from the Switching block are not forwarded. However, they will be processed if they are needed when the block is cancelled.

#### **Force**

The dimming values from Block and Scene are ignored during Force. Block and scene are equal.

#### **Permanent Off**

The dimming values from Force are not forwarded during Permanent Off.

#### **Permanent On**

The dimming values from Permanent Off are not forwarded during Permanent On.

#### **Buttons**

The channel buttons have the highest priority and can overwrite Permanent On.

## 7.2 Using the soft switch function

### 7.2.1 General

The soft switch function is a cycle consisting of switching on, dimming up, maintaining target brightness, dimming down and switching off.

### 7.2.2 Soft ON for staircase lighting

The following function is recommended for staircase lighting:

When the light push button is operated: Full brightness.

After the desired time has elapsed: Slow dimming down and basic lighting.

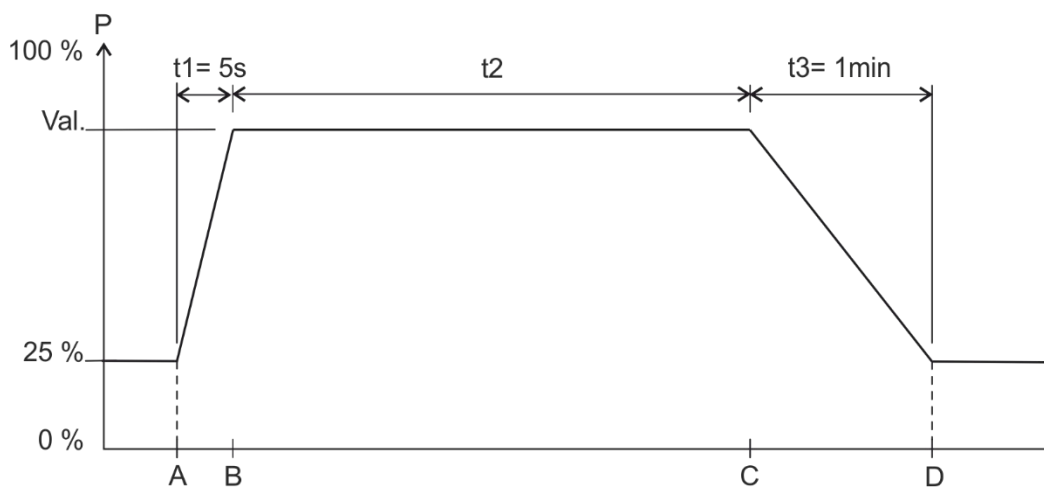

A	Push button sends <i>Soft ON</i> telegram.
t1	The <i>Soft ON</i> time is equal to 0, i.e. the "Dim up slowly" function is deactivated
B	The brightness is immediately adjusted to the configured value after <i>Soft ON</i>
t2	Configured <i>time between Soft ON and Soft OFF</i> <sup>19</sup> elapses
t2+	Perhaps, t2 has been extended with another <i>Soft ON</i> telegram
C	t2 or t2+ has elapsed, or a <i>Soft OFF</i> telegram was received: Start of the <i>Soft OFF</i> phase
t3	the brightness is gradually reduced within the configured time for <i>Soft OFF</i>
D	t3 has elapsed and it is dimmed to the configured value after <i>Soft OFF</i> (e.g. 25%). The configured minimum and maximum dimming value must be taken into account

The light can be switched off with a *Soft OFF* telegram or dimmed to the value after *Soft OFF*. A *Soft ON* telegram can be used to retrigger.

<sup>19</sup> *Soft OFF* via configured time or via *Soft OFF* telegram.

## 7.2.3 Driveway lighting

A motion detector activates the dimmer via the *Soft switching* object.  
 The lighting is dimmed up within 5 seconds if a movement is detected.  
 This delay gives the eyes enough time to adjust to the light without being dazzled.  
 The lighting is gradually dimmed down within a minute and then switched off after the configured time has elapsed or a Soft OFF telegram is received via the button or via the motion detector (cyclic).

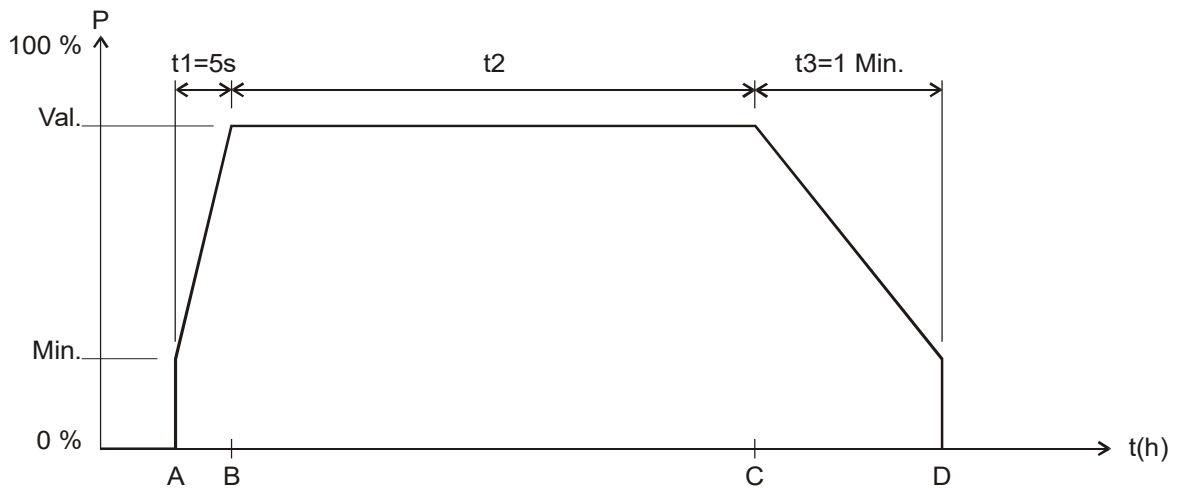

A	<i>Soft ON</i> is sent by the motion detector: The brightness is immediately adjusted to the configured <i>Minimum dimming value</i>
t1	The brightness is gradually increased within the configured time for <i>Soft ON</i> (5 s)
B	Configured value after <i>Soft ON</i> is reached
t2	Time between <i>Soft ON (1)</i> and <i>Soft OFF</i>
C	<i>Soft OFF</i> telegram was received or configured time has elapsed: Start of the <i>Soft OFF</i> phase
t3	The brightness is gradually reduced within the configured time for <i>Soft Off</i>
D	t3 has elapsed and it is dimmed to the configured value after <i>Soft OFF</i> (0%). The configured minimum and maximum dimming value must be taken into account

## 7.2.4 Simulation of daily routine

Using a time switch, it is possible to simulate an entire daily routine with sunrise and sunset. To do this, the *Time between Soft ON and Soft OFF* parameter needs to be set to *Until Soft OFF telegram* (See object *Soft switching*).

The time switch sends a Soft ON telegram (=1) in the morning and a Soft OFF telegram (=0) in the evening to object *Soft switching*.

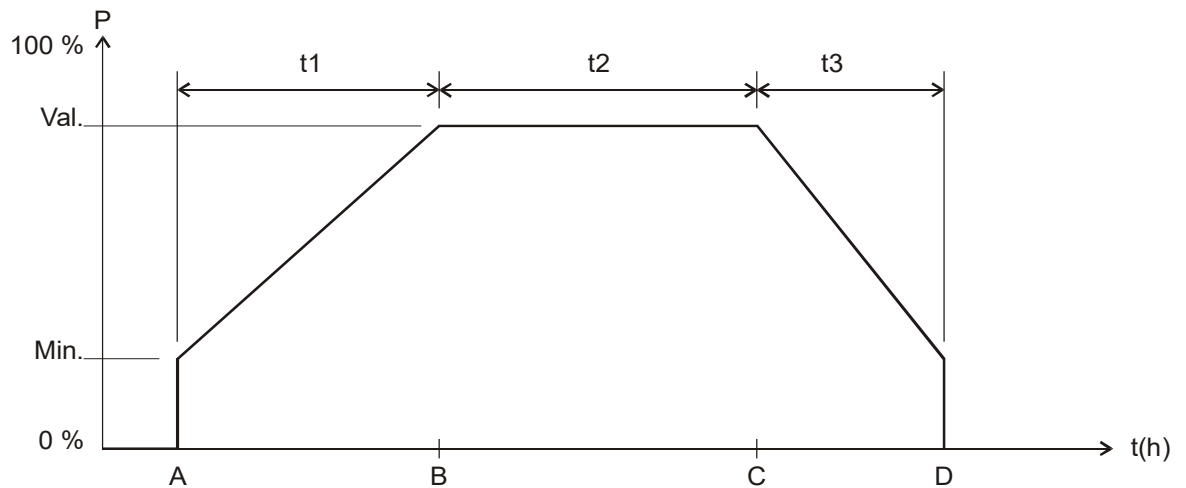

Min.	Configured <i>Minimum dimming value</i>
Val.	Target dimming value, i.e. configured <i>Dimming value after Soft ON</i>
t(h)	Time sequence

A	<i>Soft ON</i> is sent by the timer: The brightness is immediately adjusted to the configured <i>Minimum dimming value</i>
t1	The brightness is gradually increased within the configured <i>Time for Soft ON</i>
B	Configured <i>Value after Soft ON</i> is reached
t2	<i>Time between Soft ON (1) and Soft OFF telegram (0)</i> programmed in the time switch
C	<i>Soft OFF</i> telegram has been received: Start of the <i>Soft OFF</i> phase
t3	The brightness is gradually reduced within the configured <i>Time for Soft Off</i>
D	t3 has elapsed and it is dimmed to the configured value after <i>Soft OFF</i> (0%). The configured minimum and maximum dimming value must be taken into account

## 7.2.5 Retriggering and premature switch off

It is also possible to influence the soft switching process while it is still active. Depending on which phase is currently being executed, the following responses can be triggered by Soft ON and Soft OFF telegrams.

Telegram	Response
Soft ON during t1	none
Soft ON during t2	t2 is restarted
Soft ON during t3	a new Soft ON process is started. See below.
Soft OFF during t1	The Soft ON process is stopped and the Soft OFF phase started immediately. See below.
Soft OFF during t2	the Soft OFF phase starts immediately
Soft OFF during t3	none

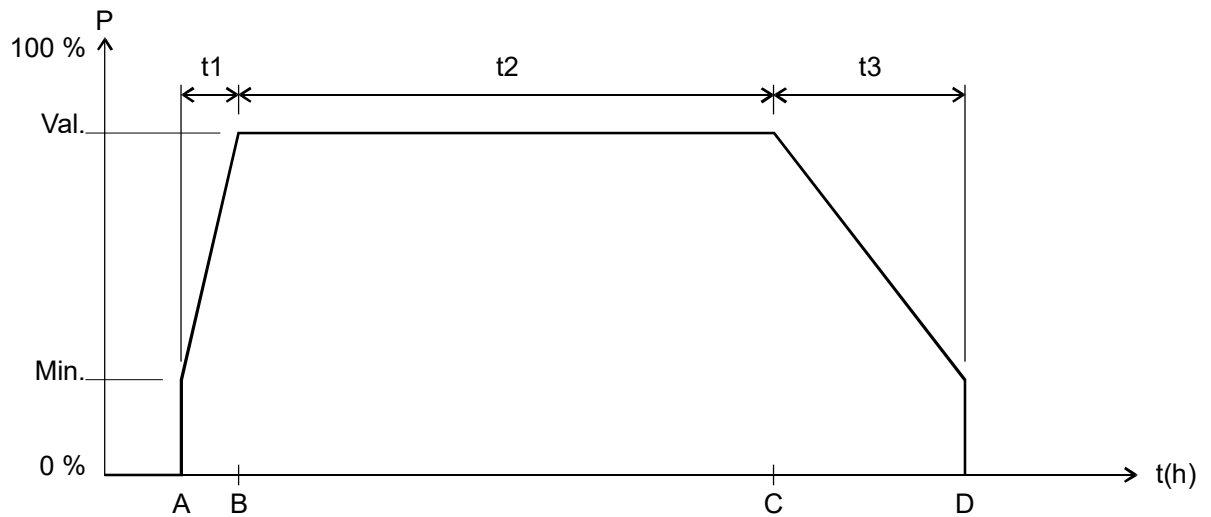



## 7.2.6 Soft OFF telegram during a Soft ON process

The duration of the Soft OFF phase ( $t_{3'}$ ) is always equivalent to the configured time, regardless of the current dimming value.

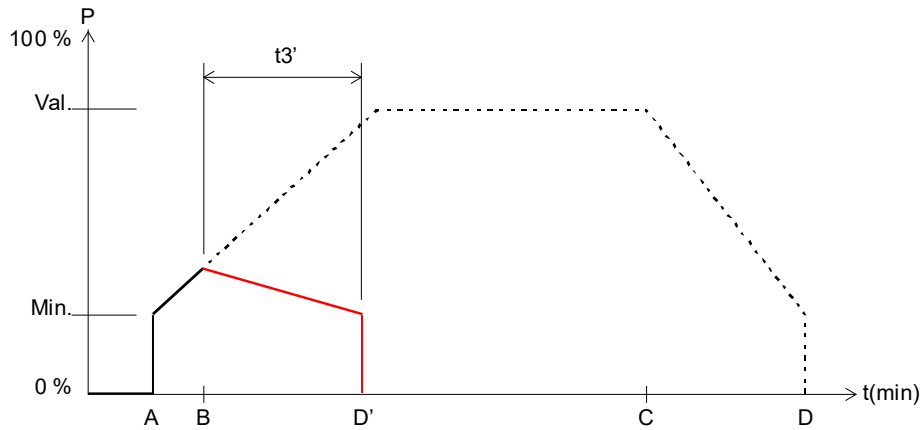

**Example 1:** Soft OFF at the start of the Soft ON phase.

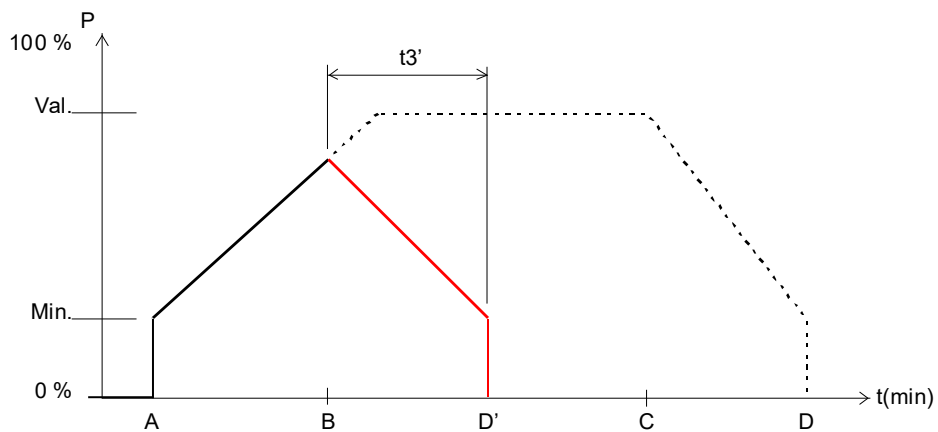

**Example 2:** Soft OFF at the end of the Soft ON phase.

A	A Soft ON process is started
B	A Soft OFF telegram is received: The Soft ON phase is interrupted and a Soft OFF phase starts.
$t_{3'}$	Duration of the Soft OFF phase = configured Soft OFF time
D'	End of the Soft OFF phase

## 7.2.7 Soft ON telegram during a Soft OFF process

The duration of the Soft ON phase ( $t_1'$ ) is always equivalent to the configured time regardless of the current dimming value.

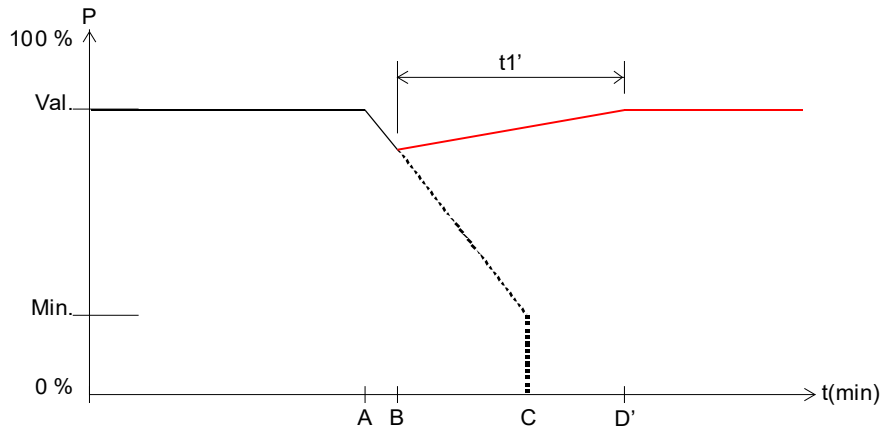

**Example 3:** Soft ON at the start of the Soft OFF phase.

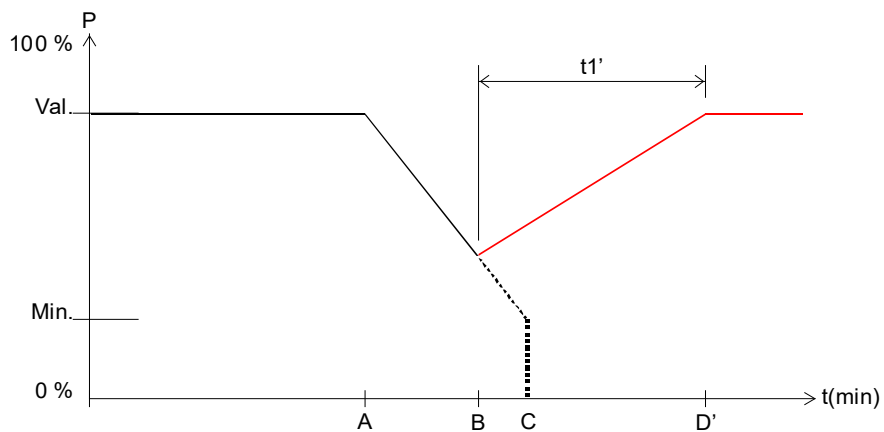

**Example 4:** Soft ON at the end of the Soft OFF phase.

Sequence:

A	A Soft OFF process is started
B	A Soft OFF telegram is received: The Soft OFF phase is interrupted and a Soft ON phase starts.
$t_1'$	Duration of the Soft ON phase = configured Soft ON time
D'	End of the Soft ON phase

### 7.3 Using the force function

**Example:** Lighting with brightness control during the daytime and minimum lighting during the night.

A brightness controller continuously measures the brightness of the room and controls the dimmer, to keep the brightness constant.

A dimming value of 20% is configured for forced operation.

In the evening at the close of work, the time switch activates forced operation, which dims down the brightness to 20%.

During the night, the lighting is switched on for a certain period of time by the night-watchmen via the central permanent ON function.

In the morning at the start of work, the time switch cancels the forced operation again and the dimmer is controlled by the brightness control.

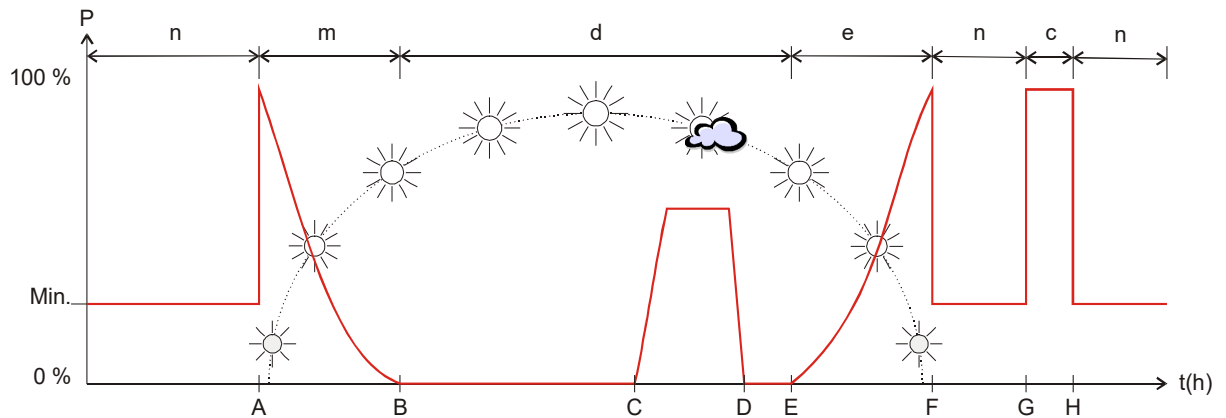

A	Forced operation is cancelled by the time switch. As the daylight is not yet bright enough, the brightness control controls the dimmer
B	The daylight is now bright enough to illuminate the room, and the dimmer is switched off
C	Heavy cloud cover, the dimmer compensates for the lack of bright daylight
D	Clear sunshine, the dimmer is turned back down
E	Late afternoon, the dimmer gradually replaces the receding daylight
F	Forced operation is activated by the time switch The dimmer reduces the light to 20%
G	Central permanent On = 1
H	Central permanent On = 0
n	During the night time, the configured value for forced operation applies
c	Night round of security guards: The lighting is switched on via central permanent On
m	Morning: Daylight increases and the brightness control slowly reduces the dimming value
e	Evening: Daylight decreases and the brightness control slowly increases the dimming value
d	During the daytime, the dimmer is controlled by the lighting control according to the brightness of the sunlight

## 7.4 4-bit telegrams (brighter/darker)

### 7.4.1 Telegram format 4-bit EIS 2 relative dimming:

Bit 3	Bits 0-1-2	
Direction	Dimming range divided into increments	
	Code	Increments
Dimming up: 1	000	<b>Stop</b>
Dimming down: 0	001	1
	010	2
	011	4
	100	8
	101	16
	110	32
	111	64 <sup>20</sup>

**Examples:** 1111 = dim brighter by 64 increments  
 0111 = dim darker by 64 increments  
 1101 = dim brighter by 16 increments

---

<sup>20</sup>typical application.

## 7.4.2 The parameters: *Switching on/off with a 4-bit telegram*

In general, the setting *yes* is required.

The setting *no* is available for use with special customer requests, e.g. in conference rooms.

The situation is described as follows:

A whole group of dimmer channels is operated by a push button (4-bit).

A certain lighting situation has been set by a scene or other means – e.g. channel 1 OFF, channel 2 40%, channel 3 50%. The requirement is to now dim up and increase the brightness of the entire scene, but the channels in the OFF state should remain off.

The parameters *Switching on/off with a 4-bit telegram* block the usual switch on/off function of the 4-bit telegram.

Parameter <i>Switch-on with 4-bit telegram</i>	4-bit Telegram	Dimmer output status	Response
<i>yes</i>	brighter/darker	Switched on (1%...100%)	Channel is normally dimmed.
	brighter	Off	Channel is switched on and dimmed brighter.
<i>no</i>	brighter	Off	Dimmer remains switched off.
	brighter/darker	Switched on (1%...100%)	Channel is normally dimmed.

Parameter <i>Switching off with a 4-bit telegram</i>	4-bit Telegram	Dimmer output status	Response
<i>yes</i>	brighter/darker	Switched on (1%...100%)	Channel is normally dimmed.
	darker	On	The channel is switched off if the push button is kept pressed for longer than approx. 2 s when the minimum brightness is reached.
<i>no</i>	darker	On	Channel can be dimmed down to the minimum brightness, but is not switched off.
	brighter/darker	Switched on (1%...100%)	Channel is dimmed in range from min. to 100% and remains switched on.

## 7.5 Scenes

### 7.5.1 Principle

The current status of a channel, or of a complete device, can be stored and retrieved later at any time via the scene function.

Each channel can participate simultaneously in up to 8 scenes. Scene numbers 1 to 64 are permitted.

Permission to participate in scenes must be granted for the relevant channel via parameter. See *Activate scenes* parameter and **Scenes** parameter page.

The current status is allocated to the appropriate scene number when a scene is saved. The previously saved status is restored when a scene number is called up.

This allows a device to be easily and conveniently integrated into any user scene.

The scenes are permanently stored and can be retained even after the application has been downloaded again.

See "All channel scene statuses" parameter on the **Scenes** parameter page.

### 7.5.2 Calling up or saving scenes:

To call up or save a scene, the relevant code is sent to the corresponding scene object.

Scene	Call up		Save	
	Hex.	Dec.	Hex.	Dec.
1	\$00	0	\$80	128
2	\$01	1	\$81	129
3	\$02	2	\$82	130
4	\$03	3	\$83	131
5	\$04	4	\$84	132
6	\$05	5	\$85	133
7	\$06	6	\$86	134
8	\$07	7	\$87	135
9	\$08	8	\$88	136
10	\$09	9	\$89	137
11	\$0A	10	\$8A	138
12	\$0B	11	\$8B	139
13	\$0C	12	\$8C	140
14	\$0D	13	\$8D	141
15	\$0E	14	\$8E	142
16	\$0F	15	\$8F	143
17	\$10	16	\$90	144
18	\$11	17	\$91	145
19	\$12	18	\$92	146
20	\$13	19	\$93	147
21	\$14	20	\$94	148
22	\$15	21	\$95	149
23	\$16	22	\$96	150
24	\$17	23	\$97	151
25	\$18	24	\$98	152
26	\$19	25	\$99	153
27	\$1A	26	\$9A	154
28	\$1B	27	\$9B	155
29	\$1C	28	\$9C	156
30	\$1D	29	\$9D	157
31	\$1E	30	\$9E	158
32	\$1F	31	\$9F	159
33	\$20	32	\$A0	160
34	\$21	33	\$A1	161
35	\$22	34	\$A2	162
36	\$23	35	\$A3	163
37	\$24	36	\$A4	164
38	\$25	37	\$A5	165
39	\$26	38	\$A6	166
40	\$27	39	\$A7	167
41	\$28	40	\$A8	168
42	\$29	41	\$A9	169
43	\$2A	42	\$AA	170
44	\$2B	43	\$AB	171
45	\$2C	44	\$AC	172
46	\$2D	45	\$AD	173
47	\$2E	46	\$AE	174
48	\$2F	47	\$AF	175
49	\$30	48	\$B0	176
50	\$31	49	\$B1	177

Scene	Call up		Save	
	Hex.	Dec.	Hex.	Dec.
51	\$32	50	\$B2	178
52	\$33	51	\$B3	179
53	\$34	52	\$B4	180
54	\$35	53	\$B5	181
55	\$36	54	\$B6	182
56	\$37	55	\$B7	183
57	\$38	56	\$B8	184
58	\$39	57	\$B9	185
59	\$3A	58	\$BA	186
60	\$3B	59	\$BB	187
61	\$3C	60	\$BC	188
62	\$3D	61	\$BD	189
63	\$3E	62	\$BE	190
64	\$3F	63	\$BF	191

**Examples** (central or channel-related):

Call up status of scene 5:

→ Send \$04 to the relevant scene object.

Save current status with scene 5:

→ Send \$84 to the relevant scene object.



### 7.5.3 Teaching in scenes without telegrams

Instead of defining scenes individually by telegram, this can be done in advance in the ETS. This merely requires the *All channel scene statuses* parameter (**Scenes** parameter page) to be set to *Overwrite on download*.

The required status can then be selected for each of the 8 possible scene numbers of a channel (= *Status after download* parameter). After the download, the scenes are already programmed into the device.

Later changes via teach-in telegrams are possible if required and can be permitted or blocked via a parameter.

### 7.5.4 Store light scenes in a push button

Scenes are normally stored in the dimmer itself. For this, the object *Call up/save scenes* is used.

However, if the lighting scenarios are to be stored **externally**, for example with a scene-capable push button, the following steps can be taken: The dimmer has one dimming object (*dimming value*) and one feedback object (*feedback in %*). Thus, 2 group addresses are used, hereafter referred to as "Gr.addr.1" and "Gr.addr.2".

### 7.5.5 Allocation of group addresses and setting of object flags

	Object	Connect with	set to sending	Flags			
				C	R	W	T
BUTTON	Telegr. Brightness value	Gr.addr.1	yes	✓	-	✓	✓
		Gr.addr.2	no				
DIMMER	Dimming value	Gr.addr.1	x	✓	-	✓	x
	Feedback in %	Gr.addr.1	no	✓	✓	-	x
		Gr.addr.2	yes				

x = user-defined

Feedback to the dimmer should **not** be configured for *cyclical sending*.

## 7.6 Conversion of percentages to hexadecimal and decimal values

Percentage value	0%	10%	20%	30%	40%	50%	60%	70%	80%	90%	100%
Hexadecimal	00	1A	33	4D	66	80	99	B3	CC	E6	FF
Decimal	00	26	51	77	102	128	153	179	204	230	255

All values from 00 to FF hex. (0 bis 255 dec.) are valid.