

Fan Coil Actuator FCA 1



FCA 1	4929200
-------	---------

Contents

1	Functional characteristics.....	4
1.1	Operation and display.....	5
1.2	Advantages of the FCA 1.....	5
1.2.1	Special features.....	5
2	Technical data.....	6
3	The application program "Fan coil actuator with control V1.1".....	7
3.1	Selection in the product database.....	7
3.2	Parameter pages.....	7
3.3	Communication objects.....	8
3.3.1	Object characteristics.....	8
3.3.2	Description of objects.....	11
3.4	Parameters.....	22
3.4.1	The General <i>parameter page</i>	22
3.4.2	Fan <i>parameter page</i>	23
3.4.3	Heating valve <i>parameter page</i>	26
3.4.4	Cooling valve <i>parameter page</i>	28
3.4.5	"Heating/cooling valve" <i>parameter page</i> (only with 2-pipe system).....	30
3.4.6	Auxiliary relay <i>parameter page</i>	32
3.4.7	E1 <i>parameter page</i>	33
3.4.8	E2 <i>parameter page</i>	34
3.4.9	<i>Drip tray monitoring parameter page</i>	34
3.4.10	<i>Set point adjustment parameter page</i>	35
3.4.11	<i>Set point values parameter page</i> (internal controller).....	37
3.4.12	<i>Operating mode and operation parameter page</i> (internal controller).....	39
3.4.13	<i>Regulation parameter page</i> (internal controller).....	41
3.4.14	<i>Filter monitoring parameter page</i>	44
3.4.15	<i>Actuating value loss parameter page</i>	45
4	Start-up.....	46
4.1	Test mode.....	46
4.2	Device LEDs in automatic mode.....	49
4.3	Mains power failure detection for 3-Point valves.....	50
5	Typical applications:.....	51
5.1	Base configuration (4-pipe system): Heating and cooling with fan coil with remote controller.....	51
5.1.1	Devices:.....	51
5.1.2	Overview.....	51
5.1.3	Objects and links.....	51
5.1.4	Important parameter settings.....	52
5.2	Base configuration (2-pipe system): Heating and cooling with fan coil with remote controller.....	53
5.2.1	Devices:.....	53
5.2.2	Overview.....	53
5.2.3	Objects and links.....	53
5.2.4	Important parameter settings.....	54
5.3	Typical application (4-pipe system):.....	55
5.3.1	Function:.....	55
5.3.2	Devices:.....	55

- 5.3.3 Overview55
- 5.3.4 Implementation:56
- Objects and links57
- 5.3.5 Important parameter settings58
- 6 Appendix59
- 6.1 Monitoring actuating value59
 - 6.1.1 Application59
 - 6.1.2 Principle59
 - 6.1.3 Practice59
- 6.2 Set characteristic valve curve60
- 6.3 Set point adjustment61
- 6.4 Set point adjustment61
 - 6.4.1 Use with an internal controller61
 - 6.4.2 Use with a remote controller61
 - 6.4.3 Format of set point adjustment: Relative62
 - 6.4.4 Format of set point adjustment: Absolute64
- 6.5 Frost protection (or heat protection) via window contact65
 - 6.5.1 with remote controller:65
 - 6.5.2 with internal controller:66
- 6.6 Dead zone66
- 6.7 Determining the current operating mode67
 - 6.7.1 New operating modes67
 - 6.7.2 Old operating modes68
 - 6.7.3 Determining the setpoint value69
 - 6.7.4 Heating and cooling in the 2 pipe system71
 - 6.7.5 Heating and cooling in the 4 pipe system71
- 6.8 Fan control.....72
 - 6.8.1 Priorities72
 - 6.8.2 Time between heating and cooling and follow-up time phase.....73
 - 6.8.3 Hysteresis74
- 6.9 Temperature control75
 - 6.9.1 Introduction75
 - 6.9.2 Response of the P-control76
 - 6.9.3 Response of the PI-control77

1 Functional characteristics

FCA1 is a EIB/KNX fan coil actuator for 2-pipe and 4-pipe systems.
FCA1 controls a fan coil with heating or cooling valve and up to 3 fan steps.

Regulation can be selected either via an external actuating value or with an integrated room thermostat.

FCA1 has 2 inputs: for window contacts or temperature measurement and drip tray monitoring.

An additional relay enables the actuation of an electrical heater bank or alternatively an electrical cooler bank.

The operating state is displayed via 9 LEDs:

In order to easily adapt to the set point values relating to living comfort and energy saving, the integrated controller has four operating modes:

- Comfort
- Standby
- Night mode
- Frost protection mode

A set point value is assigned to each operating mode.

Comfort mode is used when the room is occupied

In **Standby mode** the set point value is reduced slightly. This operating mode is used when the room is not occupied but is expected to be shortly.

In **Night mode**, the set point value is drastically reduced, since the room is not expected to be occupied for several hours.

In **Frost protection mode**, the room is controlled to a temperature that eliminates the risk of damage to the radiators through freezing at low outdoor temperatures.

This can be desirable for 2 reasons:

- The room is not occupied for several days.
- A window has been opened and no further heating is required for the time being.

The operating modes are usually controlled by a timer.
Window contacts are also recommended for optimal control.

1.1 Operation and display

FCA 1 is fitted with 9 LEDs and 2 push buttons.

- 3 red LEDs for displaying the fan step (S1...S3)
- 1 red LED for heating operation ∩∩∩
- 1 blue LED for cooling operation ❄
- 1 red LED for the auxiliary relay (C1)
- 2 red LEDs for inputs 1 and 2 (E1, E2)
- 1 red LED for test mode
- 1 push button for the fan steps ∞
- 1 push button for heating / cooling operation ❄/∩∩∩

1.2 Advantages of the FCA 1

- optional internal or external temperature controls
- suitable for 2-way and 3-way valves
- Can be used in [2- and 4-pipe systems](#)
- Easy commissioning via 2 push buttons for fan and heating / cooling operation
- Auxiliary relay for heating/cooling can also be used as a switch output
- 2 inputs for window contact or remote temperature sensor and drip tray monitoring
- [Operating mode change](#) via presence and window objects
- Adjustable effect with the inputs

1.2.1 Special features

- Control via external actuating value or with integrated room thermostat.
- Auxiliary C1 can also be controlled as switching actuator channel via the bus
- Set point value in cooling operation can be adjusted in [relation to the outdoor temperature](#)
- E1 and E2 can be used as binary inputs if required.

2 Technical data

Mains power supply:	230 +/-10 VAC 50 Hz
Power draw from the mains	max. 3 VA
Power supply via the bus	max. 10 mA
Switching capacity, triacs:	0,5 A resistive load, inductive load 0,3 A $\cos \varphi$ 0,6, minimum load 24 VAC, 5 mA, no capacitive loads, not suitable for DC
Switching capacity, auxiliary relay:	16 A resistive load 3 A inductive load $\cos \varphi$ 0,6, minimum load 12V DC 100 mA
Switching capacity, fan	8 A resistive load, 1,5 A inductive load $\cos \varphi$ 0,6, minimum load 5 V DC 10 mA
Temperature sensor wire length	max 5 m
Temperature range	-5°C ... 45 °C
Protection class	Protection class II
Protection rating	Protection rating IP 20

Class of the temperature controller	Contribution to room heating energy efficiency in %
V (as room temperature controller)	3.0
VI (as weather-dependent controller with room influence)	4.0

3 The application program

"Fan coil actuator with control V1.1"

3.1 Selection in the product database

Manufacturer	Theben AG
Product family	Heating, ventilation, air conditioning
Product type	Fan coil actuators
Program name	Fan coil actuator with control V1.1

The ETS database can be found on our website: <http://www.theben.de/>

3.2 Parameter pages

Table 1

Function	Description
General	Supported functions, operation, filter change
Fan	Number of fan steps, switching thresholds etc.
Heating valve	Base settings for heating valve
Cooling valve	Base settings for cooling valve
Heating/cooling valve	Base valve settings for 2-pipe systems
Auxiliary relay	Use of auxiliary relay C1
E1.. E2	Settings for inputs E1 and E2
Drip tray monitoring	Reaction to condensation and signal source
Set point adjustment	Set point adjustment dependent on outdoor temperature
Set point values	Set point value after download, values for night, frost mode etc.
Control	Control parameter settings for the internal temperature controller
Operating mode and operation	Base settings for changing operating modes
Filter monitoring	Base settings for filter change

3.3 Communication objects

3.3.1 Object characteristics

FCA1 features 28 communication objects.

Some objects can assume various functions depending on their configuration.

Table 2

No.	Function	Object name	Type	Flags			
				C	R	W	T
0	<i>Receive</i>	<i>Actuating value for fan</i>	1 byte EIS 6	✓	✓	✓	
	<i>Transmit</i>	<i>Heating actuating value</i>		✓	✓		✓
	<i>Receive</i>	<i>Actuating value heating</i>		✓	✓	✓	
	<i>Transmit</i>	<i>Actuating value heating/cooling</i>		✓	✓		✓
	<i>Receive</i>	<i>Actuating value heating/cooling</i>		✓	✓	✓	
	<i>Receive</i>	<i>Actuating value cooling</i>		✓	✓	✓	
1	<i>Transmit</i>	<i>Actuating value cooling</i>	1 byte EIS 6	✓	✓	✓	✓
	<i>Receive</i>	<i>Actuating value cooling</i>	1 byte EIS 6	✓	✓	✓	
	<i>Switchover</i>	<i>Heating/cooling</i>	1 bit EIS 1	✓	✓	✓	
	<i>1 = Heating disabled</i>	<i>Disable heating</i>	1 bit EIS 1	✓	✓	✓	
	<i>1 = Enable cooling</i>	<i>Enable cooling</i>	1 bit EIS 1	✓	✓	✓	
2	<i>report</i>	<i>Heating status</i>	1 bit EIS 1	✓	✓		✓
3	<i>report</i>	<i>Cooling status</i>	1 bit EIS 1	✓	✓		✓
4	<i>report</i>	<i>Fan step</i>	1 byte EIS 6/ EIS 14	✓	✓		✓
5	<i>Switching</i>	<i>Auxiliary relay</i>	1 bit EIS 1	✓	✓	✓	
	<i>report</i>	<i>Auxiliary relay status</i>	1 bit EIS 1	✓	✓		✓
6	<i>1 = Lock</i>	<i>Lock auxiliary ventilation</i>	1 bit EIS 1	✓	✓	✓	
7	<i>1 = Lock</i>	<i>Fan lock</i>	1 bit EIS 1	✓	✓	✓	
8	<i>Fan control with % value</i>	<i>Forced fan step</i>	1 byte EIS 6	✓	✓	✓	
9	<i>0 % = Auto</i> <i>1 %..100 % = Limitation</i>	<i>Limitation of fan step</i>	1 byte EIS 6	✓	✓	✓	
10	<i>Fan off</i>	<i>report</i>	1 bit EIS 1	✓	✓		✓
11	<i>Fan step 1</i>	<i>report</i>		✓	✓		✓
12	<i>Fan step 2</i>	<i>report</i>		✓	✓		✓
13	<i>Fan step 3</i>	<i>report</i>		✓	✓		✓
				C	R	W	T

Continuation:

No.	Function	Object name	Type	Flags			
				C	R	W	T
14	Report	Actual value from E1	2 bytes EIS 5	✓	✓		✓
	Report	Status of window contact at E1	1 bit EIS 1	✓	✓		✓
15	switch	Manual mode= 1 / Auto = 0	1 bit EIS 1	✓	✓	✓	
16	Report	Status of drip tray monitoring	1 bit EIS 1	✓	✓		✓
	Input	Status of drip tray monitoring		✓	✓	✓	
	Report	Status of E2		✓	✓		✓
17	Input	Dew point alarm	1 bit EIS 1	✓	✓	✓	
18	Input	Outside temperature	2 bytes EIS 5	✓	✓	✓	
19	Delta in K	Adjust set point	2 bytes EIS 5	✓	✓		✓
	Value in °C			✓	✓		✓
20	1 = Actuating value loss	Actuating value loss	1 bit EIS 1	✓	✓		✓
	Sensor failure	Sensor failure	1 bit EIS 1	✓	✓		✓
21	Operating mode preset	Operating mode preset	1 byte	✓	✓	✓	
	1 = Night mode	Night mode < - > Standby	1 bit EIS 1	✓	✓	✓	
22	Input for presence signal	Presence	1 bit EIS 1	✓	✓	✓	
	1 = Comfort mode	Comfort		✓	✓	✓	
23	Input for window contact	Window	1 bit EIS 1	✓	✓	✓	
	1 = Frost protection	Frost protection		✓	✓	✓	
24	Transmit	Current operating mode	1 byte	✓	✓		✓
25	Receive	Manual adjustment	2 bytes	✓	✓	✓	
26	Receive	Base set point value	2 bytes	✓	✓	✓	
27	Transmit	Current set point value	2 bytes	✓	✓		✓
28	Switchover	Heating/cooling	1 bit EIS 1	✓	✓	✓	
29	1 = No energy medium	No energy medium	1 bit EIS 1	✓	✓		✓
	1 = Heating disabled	Heating required but heating disabled		✓	✓		✓
	1 = Cooling disabled	Cooling required but cooling disabled		✓	✓		✓
30	Time in hours	Fan duty time since last filter change	2 byte EIS 10	✓	✓		✓
31*	1 = Change	Change filter	1 bit EIS 1	✓	✓	✓	✓
32	Report	Test mode	1 bit EIS 1	✓	✓		✓
				C	R	W	T

* Also serves as reset input for filter change status.

Key

Flag	Name	Meaning
C	Communication	Object can communicate
R	Read	Object status can be viewed (ETS / display etc.)
W	Write	Object can receive
T	Transmit	Object can transmit

Table 3

Number of communication objects	33
Number of group addresses	64
Number of associations	64

3.3.2 Description of objects

- **Object 0** "*Actuating value for fan, Actuating value heating/cooling, transmit or receive Actuating value cooling*".

The function of the object is connected with the parameters "*Supported function*" and "*Type of controller used*" on the "[General](#)" parameter page".

Table 4.

<i>Supported function</i>	<i>Kind of controller used and Function of object</i>		System type
	<i>internal controller</i>	<i>remote controller</i>	
<i>Heating</i>	Transmits the current actuating value of heating valve	Receives the actuating value for the heating valve	4-pipe system or heating only system
<i>Cooling</i>	Transmits the current actuating value of cooling valve	Receives the actuating value for the cooling valve	cooling only system
<i>Heating and cooling</i>	Transmits the current actuating value of the common heating and cooling valve	Receives the actuating value for the common heating and cooling valve	2-pipe system
<i>Ventilator</i>	receives the actuating value for fan control		Ventilation

- **Object 1** "*Actuating value cooling, Heating/cooling, Disable heating, Enable cooling*"

The function of the object is connected with the parameters "*Supported function*" and "*System type*" on the "[General](#)" parameter page.

Table 5

Supported function	System type	
	2-pipe system	4-pipe system
<i>Heating and cooling</i>	Switch between heating and cooling operation Heating = 0 Cooling = 1	With remote controller: Receive actuating value cooling With internal controller: Transmit actuating value cooling
<i>Heating</i>	Disable heating: 1 on this object disables the heating function. Lock can be cleared with a 0. After reset, object value = 0, i.e. heating permitted	
<i>Cooling</i>	Enable cooling: 1 on this object permits cooling function. 0 on this object disables the cooling function. After reset, object value = 1, i.e. cooling permitted	

- **Object 2 "heating status"**

Transmits the current heating status:

1 = Actuating value heating is greater than 0%, heating is switched on.

0 = Actuating value heating is 0%, heating is currently switched off.

- **Object 3 "Cooling status"**

Transmits the current cooling status:

1 = Actuating value cooling is greater than 0%, cooling is switched on.

0 = Actuating value cooling is 0%, cooling is currently switched off.

- **Object 4 "Fan step"**

Reports the current fan step.

2 formats can be selected:

- as 1 byte number between 0 and 3.

- as percentage value

See [Format and cycle time for object fan step](#) parameter

- **Object 5 "Auxiliary relay, auxiliary relay status"**

The function of this object is dependent on the "Switching on auxiliary relay" parameter on ["Auxiliary relay"](#) parameter page.

Using the "via object" setting, the auxiliary relay can be controlled externally via the bus with object 5.

With all other settings object 5 reports the current status of auxiliary relay.

- **Object 6 "Disable auxiliary ventilation"**

Disable object for the "auxiliary ventilation" function if this is activated.

1 = Lock

0 = Unlock

- **Object 7 "Fan lock"**

Disable object for fan control.

1 = Disable fan (= Fan OFF)

0 = Automatic operation

- **Object 8 "Forced fan step %"**

The desired fan step in forced mode can be set as percentage value between 0 % and 100 % . This is can be done either by using the switch on the RAM 713 FC room thermostat or via an EIB sensor (e.g. push button) configured for that purpose
Forced function is activated by [Object 15](#).

Example:

Recommended forced telegrams for the following settings on the "Fan"parameter page:

Switch-on threshold for fan step 1 = 10 %

Switch-on threshold for fan step 2 = 40 %

Switch-on threshold for fan step 3 = 70 %

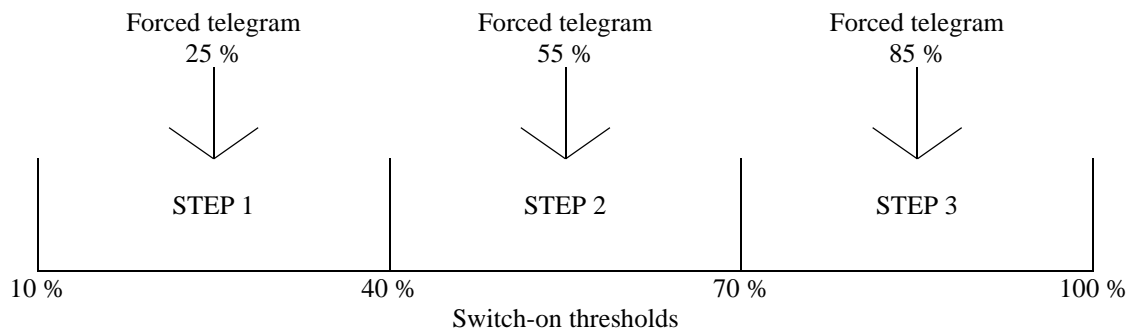

Figure 1

- **Object 9 "Limitation of fan step"**

This object can be used to set the maximum permitted actuating value and the associated maximum fan step.

The following values are used.

Table 6

Value	Highest permissible fan step
0 %	The fan is not switched on
1 % .. 99%	Maximum permissible fan step for normal and forced operation
100 %	No limit, automatic operation (= object value after reset)

Example:

Configured switch-on thresholds:

Fan step 1 = 10 %

Fan step 2 = 40 %

Fan step 3 = 70 %

Table 7

Received value at object 9	Maximum fan step
0 % .. 9 %*	Fan is not switched on
10 % .. 39 %	1
40 % .. 69 %	2
70 % .. 100 %**	3

* Value is under the switch-on threshold for step 1, the fan cannot be switched on.

** Value is greater/equal to the switch-on threshold for level 3, i.e. no limit

- **Object 10 "Fan off"**

Report object for the fan status.
Transmits a 1 if the fan is switched off.

- **Object 11 "Fan step 1"**

Report object for the fan status.
Transmits a 1 if the fan is switched to step 1.

- **Object 12 "Fan step 2"**

Report object for the fan status.
Transmits a 1 if the fan is switched to step 2.

- **Object 13 "Fan step 3"**

Report object for the fan status.
Transmits a 1 if the fan is switched to step 3.

- **Object 14 "Actual value from EI, Status window contact to EI"**

The object function depends on the "Function of EI" parameter on the "EI" parameter page.

Table 8

Parameters "Function of EI"	Meaning
<i>EI = Window contact</i>	Transmits the current status of the window contact to the bus. → Only available when using a remote controller.
<i>EI = Actual value sensor</i>	Transmits the current measured room temperature to the bus. → Fixed setting when using an internal controller.

- **Object 15 "Manual mode = 1 / Auto = 0"**

This object is used to activate or leave the forced fan step.
The desired fan step for the forced operation is set by [Object 8](#).

The forced fan step has no effect on valve control.

- **Object 16 "Drip tray monitoring status"**

The function of this object depends on the "Source for drip tray monitoring" parameter on the "Drip tray monitoring" page.

Table 9

Parameters „Source for drip tray monitoring“	Object function
E2	Transmits the status of the drip tray monitoring
Object 16	Receives the status of the drip tray monitoring from the bus

- **Object 17 "Dew point alarm"**

Receives the dew point alarm telegrams.

1 = Alarm

Note: Same behaviour as for drip tray monitoring

- **Object 18 "Outdoor temperature"**

Receives the outdoor temperature for [Set point adjustment](#)

- **Object 19 "Adjust set point"**

Reports the current set point adjustment as an amount or as a differential.

The *format of the correction value* is set on the *set point adjustment* parameter page.

Table 10

Format of correction value	Object function	Example
<i>Absolute</i>	Transmits the amount: <i>Base set point without adjustment</i> + <i>Set point correction</i> as set point value for additional temperature controls.	<i>Base set point without adjustment</i> = 20°C. <i>Set point adjustment</i> = +2 K The object transmits : 22 °C *
<i>Relative</i>	Calculated set point adjustment (in Kelvin) based on outdoor temperature.	<i>Base set point without adjustment</i> = 20°C. <i>Set point adjustment</i> = +2 K The object transmits : 2 K *

***Important:** If the *Use set point adjustment for regulation* parameter is set on "yes", the *base setpoint after reset* (i.e. set point for the internal controller) is also adjusted at the same time. In our example it is raised by 2 K in both cases.

- **Object 20 "Actuating value loss, sensor failure"**

The function of the object depends on the "Type of controller used" parameter on the "General" parameter page.

Table 11

„Type of controller used“	Object function
<i>Internal controller</i>	Reports error if the temperature sensor connection is interrupted or shorted.
<i>Remote controller*</i>	Reports whether the actuating value is being received at regular intervals. 1 = Actuating value loss 0 = Actuating value OK

* Sensor errors are only reported with use of an internal controller.

- **Object 21 "Operating mode preset, Night <-> Standby"**

The function of the object depends on the "Object for operating mode preset" parameter on the "Operating mode and operation" parameter page.

Table 12

„Objects for setting operating mode“	Object function
<i>new: Operating mode, presence, window status</i>	1 byte object. One of 4 operating modes can be directly activated.* 1 = Comfort, 2 = Standby, 3 = Night, 4 = Frost protection (heat protection) The details in brackets refer to cooling mode.
<i>old: Comfort, night, frost</i>	With this setting, this object is a 1 bit object. Night or standby operating mode can be activated. 0=Standby 1=Night

* Only values from 1 to 4 allowed.

- **Object 22 "Comfort , Presence"**

The object function depends on the "Object for operating mode preset" parameter on the "Operating mode and operation" parameter page.

Table 13

„Objects for setting the operating mode“	Object function
<i>new: Operating mode, presence, window status</i>	<p>Presence: The status of a presence indicator (e.g. sensor, movement indicator) can be received via this object. A 1 on this object activates the comfort operating mode.</p>
<i>old: Comfort, night, frost</i>	<p>Comfort: A 1 on this object activates the comfort operating mode. This operating mode takes priority over night and standby operation. Comfort mode is deactivated by sending a 0 to the object.</p>

- **Object 23 "Window, frost protection"**

Table 14

„Objects for setting the operating mode“	Object function
<i>new: Operating mode, presence, window status</i>	<p>Window position: The status of a window contact can be received via this object. A 1 on this object activates the frost / heat protection operating mode.</p>
<i>old: Comfort, night, frost</i>	<p>Frost/heat protection: A 1 on this object activates the frost protection operating mode. The heat protection mode is activated during cooling. The frost/heat protection operating mode takes top priority. The frost/heat protection mode remains until it is cleared again by entering a 0.</p>

- **Objekt 24 "Current operating mode"**

Transmits the current operating mode as a 1 byte value (see below: Coding of operating modes). The transmission response can be set on the "Operating mode" parameter page.

Table 15: Coding of HVAC operating modes:

Value	Operating mode
1	<i>Comfort</i>
2	<i>Standby</i>
3	<i>Night</i>
4	<i>Frost protection/heat protection</i>

- **Object 25 "Manual adjustment"**

Only available with internal controller.

The object receives a temperature differential in EIS 5 format.

The desired room temperature (current set point) can adjusted from the *base set point value* by this differential.

New set point value (heating) = Current set point + manual adjustment.

New set point (cooling) = Current set point + manual adjustment + dead zone + set point adjustment.

Values outside the configurable range (see *Limitation of manual adjustment* on the [Operating mode and operation](#) parameter page) are limited to the highest or lowest value.

- **Object 26 "Base set point "**

The base set point is first specified via the application at start-up and stored in the "*base set point*" object.

Afterwards, it can be specified again at any time using *Object 26* (limited by minimum or maximum valid set point value).

If the bus voltage fails, this object is backed up and the last value is restored when the bus voltage returns.

The object can be described as required.

- **Object 27 "Current set point value"**

Transmits the current set point value valid for control in EIS 5 format.

- **Object 28 "Heating/cooling"**

Is used if automatic switchover between heating and cooling is not required or not possible. The cooling operation is forced via 1 and the heating operation via 0.

Only available in 4-pipe system when switching via object (internal controller).

- **Object 29 "No energy medium, heating required but heating disabled, cooling required but cooling disabled"**

Error reporting object:

An error is reported in the following cases:

Case 1: Heating operation is forced via the *heating/cooling* object, however the room temperature is so far above the set point temperature that cooling is required.

Case 2: Cooling operation is forced via the *heating/cooling* object, however the room temperature is so far above the set point temperature that heating is required.

- **Object 30 "Fan duty time since last filter change"**

This object is available if the *Should filter change be reported* parameter is set to *yes* .

If selected, the object transmits the current status of internal fan elapsed-time counter. The fan runtime is transmitted in hours.

The counter is reset via object 31.

- **Object 31 "Change filter "**

This object is available if the "*Should a filter change be reported*" parameter is set to "yes".

This object has 2 functions:

1. As a transmission object:
Sends a 1 once the configured operating time of the fan has been reached.
See "*Report filter change after fan operation (1..127 weeks)*" on the "[Filter monitoring](#)" parameter page.
2. As a receive object:
Reset for the *Change filter* status and the fan elapsed-time counter (object 30).
0 = Reset.

- **Object 32 "Test mode"**

Transmits a telegram if the device is set to test mode
(1 = Test mode).

See also: [Test mode](#) in the start up chapter.

3.4 Parameters

The standard values are **in bold**.

3.4.1 The General *parameter page*

Different parameters are displayed according to the supported functions selection.

Table 16

Designation	Values	Meaning
<i>Supported function</i>	<i>Fan</i> <i>Heating</i> <i>Cooling</i> <i>Heating and cooling</i>	Available system
<i>Heating system</i>	<i>Fan coil</i> <i>Convector</i>	Type of heating system
<i>Cooling system</i>	<i>Fan coil</i> <i>Convector</i>	Type of cooling system
<i>System type</i>	<i>2-pipe system</i> <i>4-pipe system</i>	There is one single water circuit that is filled with cooling or heating medium according to the season. The system consists of two separate water circuits for heating and cooling.
<i>Type of controller used</i>	<i>Internal controller</i> <i>Remote controller</i>	The FCA 1 measures and controls the room temperature itself. The FCA 1 receives an actuating value from a remote controller and behaves as an actuator.
<i>Test mode</i>	<i>activated</i> <i>disabled</i>	After reset the user can change to <i>test mode</i> by pressing a button. See also: Test mode <i>Test mode</i> is not possible.
<i>Should a filter change be reported</i>	No <i>yes</i>	If YES is selected then the " <i>Filter monitoring</i> " parameter page is blended in.
<i>Should the actuating value be monitored</i>	No <i>Yes</i>	See appendix: Monitoring the actuating value

3.4.2 Fan parameter page

IMPORTANT: The difference between the 2 switch-on thresholds must be **at least 15%** .

Table 17

Designation	Values	Meaning
Number of fan steps	1 step 2 steps 3 steps	Available number of fan steps.
Switch-on threshold for fan step 1	0,4 %, 5 %, 10 % , 15 %, 20 %, 25 %, 30 % 35 %, 40 %	Determines from which actuating value step 1 should switch on.
Switch-on threshold for fan step 2	0 %, 10 %, 20 % 30 %, 40 % , 50 % 60 %, 70 %, 80 % 90 %, 100 %	Determines at which actuating value step 1 should change to step 2.
Switch-on threshold for fan step 3	0 %, 10 %, 20 % 30 %, 40 %, 50 % 60 %, 70 % , 80 % 90 %, 100 %	Determines at which actuating value step 2 should change to step 3.
Fan starting strategy	direct via step 1, 5 s via step 1, 10 s via step 1, 15 s via step 1, 20 s via step 1, 25 s via step 1, 30 s via maximum step, 5 s via maximum step, 10 s via maximum step, 15 s via maximum step, 20 s via maximum step, 25 s via maximum step, 30 s via maximum step, 40 s via maximum step, 50 s via maximum step, 60 s	The fan should start directly at the configured fan step. The fan should always start at the lowest level and switch to the configured step after a delay. The fan should always start at the highest level and switch to the configured step after a delay. This fan starting strategy must be selected if this is recommended by the fan manufacturer. Important: The starting fan step will neither be displayed nor transmitted during operation.
Minimum time to stay within a fan step	None, 1 min, 2 min , 3 min 4 min, 5 min, 6 min, 7 min 8 min, 9 min, 10 min, 11 min 12 min, 13 min, 14 min, 15 min	Avoids too frequent a change between fan steps if the actuating value suddenly changes.

Continuation:

Designation	Values	Meaning
<i>Additional ventilation</i>	<p>no</p> <p><i>every 30 min for 3 min step 1</i> <i>every 30 min for 5 min step 1</i> <i>every 30 min for 3 min step 2</i> <i>every 30 min for 5 min step 2</i> <i>every 60 min for 3 min step 1</i> <i>every 60 min for 5 min step 1</i> <i>every 60 min for 3 min step 2</i> <i>every 60 min for 5 min step 2</i></p> <p><i>permanent ventilation step 1</i> <i>permanent ventilation step 2</i> <i>permanent ventilation step 3</i></p>	<p>no additional ventilation</p> <p>The fan should regularly switch on for the configured time independently of the actuating value.</p> <p>Regardless of the actuating value, the fan should permanently run at the selected step.</p>
<i>Warm start</i>	<p>no warm start</p> <p><i>30 s, 1 min, 1 min 30 s,</i> <i>2 min, 2 min 30 s, 3 min,</i> <i>3 min 30 s, 4 min, 4 min 30 s,</i> <i>5 min, 5 min 30 s, 6 min,</i> <i>6 min 30 s, 7 min,</i> <i>7 min 30 s</i></p>	<p>The fan starts as soon as the valve is opened.</p> <p>The valve is opened first. The fan only starts after configured time has elapsed to prevent cold air being blown into the room. See appendix: Time between heating and cooling and follow-up time phase</p>
<i>Follow-up time for utilisation of remaining energy</i>	<p>No fan follow-up</p> <p><i>30 s, 1 min, 2 min, 3 min</i> <i>4 min, 5 min, 6 min, 7 min</i> <i>8 min, 9 min, 10 min, 15 min</i> <i>20 min, 30 min</i> <i>until valve is closed</i></p>	<p>The fan is turned off immediately if the valve is closed.</p> <p>If the valve is closed, the fan will carry on running for the set time to feed the remaining energy in the device into the room.</p>

Continuation:

Designation	Values	Meaning
<p><i>Cyclical transmission of fan step</i></p>	<p><i>Format counter value, don't transmit cyclically</i></p> <p><i>Format counter value, Cycle time 3 min ... 60 min</i></p> <p><i>Format percentage, don't transmit cyclically</i></p> <p><i>Format percentage, Cycle time 3 min ... 60 min</i></p>	<p>Object 4 transmits the current fan step as a number between 0 and 3. Only at change.</p> <p>Cyclically and in the event of change</p> <p>Object 4 transmits the configured threshold value for the current step as a percentage: Only at change.</p> <p>cyclically and in the event of change</p> <p>Example: Configured thresholds: Fan step 1 = 10% Fan step 2 = 40% Fan step 3 = 70% If fan step 2 is running, object 4 transmits a value of 40% Cycle time can be set for between 3 and 60 minutes.</p>

3.4.3 Heating valve parameter page

Table 18

Designation	Values	Meaning
<i>Type of valve</i>	<i>2-point</i> <i>3-point</i>	For standard actuators (Open / closed) For linear motorised actuators
<i>2-point valve</i>	<i>Effect of the valve</i>	Valve opens when voltage is applied <i>Valve closes when voltage is applied</i>
	<i>PWM time</i>	<i>3 min, 4 min, 5 min, 6 min</i> <i>7 min, 8 min, 9 min, 10 min</i> <i>11 min, 12 min, 13 min, 14 min</i> <i>15 min, 16 min, 17 min, 18 min</i> <i>19 min, 20 min, 21 min, 22 min</i> <i>23 min, 24 min, 25 min, 26 min</i> <i>27 min, 28 min, 29 min, 30 min</i>
	<i>Time for closing heating valve</i>	<i>0 min, 1 min, 2 min, 3 min,</i> <i>4 min, 5 min, 6 min, 7 min,</i> <i>8 min, 9 min, 10 min, 15 min,</i> <i>20 min, 30 min</i>
<i>3-point valve</i>	<i>Time for 100 % hub (5 .. 2,000s)</i>	<i>Manual input</i> <i>5 ... 2000s (Standard 90 s)</i>
	<i>New position at change of</i>	<i>0 %,</i> <i>1 %, 2 %, 3 %,</i> <i>4 %, 5 %, 6 %, 7 %</i> <i>8 %, 9 %, 10 %, 11 %</i> <i>12 %, 13 %, 14 %, 15 %</i>

Continuation:

Designation	Values	Meaning
<i>Open from actuating value*</i>	0,4 % 5 %, 10 % 15 %, 20 %, 25 % 30 %, 35 %, 40 %	Valve is opened even with minimum actuating value. Valve is only opened once the actuating value has reached the set value. This setting prevents possible whistling when valve is open.
<i>Minimum valve setting*</i>	0 % , 5 %, 10 %, 15 % 20 %, 25 %, 30 %, 35 % 40 %, 45 %, 50 %	Minimum permissible valve setting with actuating value < > 0%.
<i>Maximum valve setting from actuating value*</i>	0,4 %, 10 %, 20 %, 30 % 40 %, 50 % , 60 %, 70 % 80 %, 90 %, 100 %	Actuating value from which the valve accepts maximum valve setting.
<i>Maximum valve setting*</i>	55 %, 60 %, 65 %, 70 % 75 %, 80 %, 85 % 90 %, 95 %, 100 %	Maximum permissible valve setting
<i>Times between heating and cooling</i>	0 min , 1 min, 2 min, 3 min, 4 min, 5 min, 6 min, 7 min, 8 min, 9 min, 10 min, 15 min, 20 min, 30 min	Delay when changing from heating to cooling after the heating valve is completely closed. The cooling valve can only be opened after this time has expired. See appendix: Time between heating and cooling and follow-up time phase
<i>Cyclical transmission of heating status every</i>	do not send cyclically 3 min 5 min 10 min 15 min 20 min 30 min 60 min	Cyclical transmission time for heating status (object 2)

* Setting characteristic valve curve; see appendix: [Setting characteristic valve curve](#).

3.4.4 Cooling valve parameter page

Table 19

Designation	Values	Meaning	
<i>Type of valve</i>	<i>2-point</i> <i>3-point</i>	For standard actuators (Open / closed) For linear motorised actuators	
<i>2-point valve</i>	<i>Effect of the valve</i>	Valve opens when voltage is applied For valves closed without current Valve closes when voltage is applied For valves opened without current	
	<i>PWM time</i>	<i>3 min, 4 min, 5 min, 6 min</i> <i>7 min, 8 min, 9 min, 10 min</i> <i>11 min, 12 min, 13 min, 14 min</i> <i>15 min, 16 min, 17 min, 18 min</i> <i>19 min, 20 min, 21 min, 22 min</i> <i>23 min, 24 min, 25 min, 26 min</i> <i>27 min, 28 min, 29 min, 30 min</i>	An actuation cycle consists of one on and one off process and forms a PWM period. Example: Actuating value= 20%, PWM time = 10 min: In an actuating cycle of 10 min, 2 min switched on and 8 min switched off (i.e. 20% on/ 80% off).
	<i>Time for closing cooling valve</i>	<i>0 min, 1 min, 2 min, 3 min</i> <i>4 min, 5 min, 6 min</i> <i>7 min, 8 min, 9 min</i> <i>10 min, 15 min, 20 min</i> <i>30 min</i>	Adjustment of selected actuator. Prevents the heating valve opening too early.
<i>3-point valve</i>	<i>Time for 100 % hub (5 .. 2,000s)</i>	<i>Manual input</i> <i>5 ... 2000s (Standard 90 s)</i>	Adjustment to the actuator used to guarantee exact positioning.
	<i>New position at change of</i>	<i>0 %,</i> <i>1 %, 2 %, 3 %,</i> <i>4 %, 5 %, 6 %, 7 %</i> <i>8 %, 9 %, 10 %, 11 %</i> <i>12 %, 13 %, 14 %, 15 %</i>	The valve is re-positioned each time the control variable is changed. The valve is never repositioned until the control variable has changed from the last position by more than the set value. Enables frequent, small positioning increments to be suppressed.

Continuation:

Designation	Values	Meaning
<i>Open from actuating value*</i>	0,4 % , 5 %, 10 % 15 %, 20 %, 25 % 30 %, 35 %, 40 %	Valve is opened even with minimum actuating value. Valve is only opened once the actuating value has reached the set value. This setting prevents possible whistling when valve is open.
<i>Minimum valve setting*</i>	0 % , 5 %, 10 %, 15 %, 20 %, 25 %, 30 %, 35 %, 40 %, 45 %, 50 %	Minimum permissible valve setting with actuating value < > 0%.
<i>Maximum valve setting from actuating value*</i>	0,4 %, 10 %, 20 %, 30 % 40 %, 50 % , 60 %, 70 % 80 %, 90 %, 100 %	Actuating value from which the valve accepts maximum valve setting.
<i>Maximum valve setting*</i>	55 %, 60 %, 65 %, 70 % 75 %, 80 %, 85 % 90 %, 95 %, 100 %	Maximum permissible valve setting
<i>Cooling status transmits every</i>	do not send cyclically 3 min 5 min 10 min 15 min 20 min 30 min 60 min	Cyclical transmission time for cooling status (object 2)

* Setting characteristic valve curve; see appendix: [Set characteristic valve curve](#).

3.4.5 "Heating/cooling valve" parameter page (only with 2-pipe system)

Table 20

Designation	Values	Meaning	
<i>Type of valve</i>	<i>2-point</i> <i>3-point</i>	For standard actuators (Open / closed) For linear motorised actuators	
<i>2-point valve</i>	<i>Effect of the valve</i>	Valve opens when voltage is applied <i>Valve closes when voltage is applied</i>	For valves closed without current For valves opened without current
	<i>PWM time</i>	<i>3 min, 4 min, 5 min, 6 min</i> <i>7 min, 8 min, 9 min, 10 min</i> <i>11 min, 12 min, 13 min, 14 min</i> <i>15 min, 16 min, 17 min, 18 min</i> <i>19 min, 20 min, 21 min, 22 min</i> <i>23 min, 24 min, 25 min, 26 min</i> <i>27 min, 28 min, 29 min, 30 min</i>	An actuation cycle consists of a switch-on and a switch-off process and forms a PWM period. Example: Actuating value= 20%, PWM time = 10 min: In an actuating cycle of 10 min, 2 min switched on and 8 min switched off (i.e. 20% on/ 80% off).
	<i>Time for closing valve</i>	<i>0 min, 1 min, 2 min,</i> <i>3 min</i> , <i>4 min, 5 min,</i> <i>6 min, 7 min, 8 min,</i> <i>9 min, 10 min, 15 min,</i> <i>20 min, 30 min</i>	Adjustment of selected actuator.
<i>3-point valve</i>	<i>Time for 100 % hub</i> (5 .. 2,000s)	<i>Manual input</i> 5 ... 2000s (Standard 90 s)	Adjustment to the actuator used to guarantee exact positioning.
	<i>New position at change of</i>	0 %, 1 %, 2 %, 3 %, 4 %, 5 % , 6 %, 7 % 8 %, 9 %, 10 %, 11 % 12 %, 13 %, 14 %, 15 %	The valve is re-positioned each time the control variable is changed. The valve is never repositioned until the control variable has changed from the last position by more than the set value. Enables frequent, small positioning increments to be suppressed

Continuation:

Designation	Values	Meaning
<i>Open from actuating value*</i>	0,4 % , 5 %, 10 % 15 %, 20 %, 25 % 30 %, 35 %, 40 %	Valve is opened even with minimum actuating value. Valve is only opened once the actuating value has reached the set value. This setting prevents possible whistling when valve is open.
<i>Minimum valve setting*</i>	0 % , 5 %, 10 %, 15 %, 20 %, 25 %, 30 %, 35 %, 40 %, 45 %, 50 %	Minimum permissible valve setting with actuating value < > 0%.
<i>Maximum valve setting from actuating value*</i>	0,4 %, 10 %, 20 %, 30 % 40 %, 50 % , 60 %, 70 % 80 %, 90 %, 100 %	Actuating value from which the valve accepts maximum valve setting.
<i>Maximum valve setting*</i>	55 %, 60 %, 65 %, 70 % 75 %, 80 %, 85 % 90 %, 95 %, 100 %	Maximum defined valve setting
<i>All send heating or cooling status</i>	do not send cyclically 3 min 5 min 10 min 15 min 20 min 30 min 60 min	Cyclical transmission time for heating/cooling status (object 2)

* Setting characteristic valve curve; see appendix: [Set characteristic valve curve](#).

3.4.6 Auxiliary relay *parameter page*

Table 21

Designation	Values	Meaning
<i>Switching on auxiliary relay</i>	<i>Via object</i>	The auxiliary relay is only controlled via the bus (see object 5)
	<i>If heating is required</i>	The auxiliary relay is switched on as soon as the heating actuating value is above 0%.
	<i>If cooling is required</i>	The auxiliary relay is switched on as soon as the cooling actuating value is above 0%.
	<i>Combined with heating valve</i>	The auxiliary relay only switches on if the heating valve is actually open*.
	<i>Combined with cooling valve</i>	The auxiliary relay only switches on if the cooling valve is actually open*.
<i>All send auxiliary relay status</i>	<i>do not send cyclically</i> <i>3 min</i> <i>5 min</i> <i>10 min</i> <i>15 min</i> <i>20 min</i> <i>30 min</i> <i>60 min</i>	Cyclical transmission time for the additional relay status. With the <i>via object</i> setting, the status is not transmitted.

* With an adjusted characteristic valve curve, the valve can remain closed with a low actuating value.

3.4.7 E1 parameter page

Table 22

Designation	Values	Meaning	
<i>Function of E1</i>	E1 = Window contact <i>E1 = Actual value sensor</i>	A window contact is connected to input E1. A temperature sensor (Order nr. 907 0 321) is connected to E1	
<i>E1 = Window</i>	<i>Direction of operation of window contact</i>	Contact closed = window closed Contact open = window closed	Type of connected contact (NC or NO)
	<i>Window contact status transmits every</i>	do not send cyclically <i>3 min, 5 min, 10 min, 15 min, 20 min, 30 min, 60 min</i>	Cyclical transmission time for window contact
<i>E1 = Actual value sensor</i>	<i>Actual value offset in 0.1 K (-50..50)</i>	<i>manual input -50 ... 50</i>	Positive or negative adjustment of measured temperature in 1/10 K increments. Examples: a) FCA 1 transmits 20.3°C. A room temperature of 21.0°C is measured using a calibrated thermometer. In order to increase the temperature of FCA 1 to 21 °C, "7" (i.e. 7 x 0.1K) must be entered. b) FCA 1 transmits 21.3°C. 20.5°C is measured . To reduce the transmitted temperature to 20.5 °C, "8" (i.e. -8 x 0.1K) must be entered.
	<i>Transmits the current value on change</i>	<i>only cyclically</i> <i>every 0.2 K</i> <i>every 0.3 K</i> every 0.5 K <i>every 1 K</i>	Is the current room temperature to be transmitted? If so, from which minimum change should this be retransmitted? This setting keeps the bus load as low as possible.
	<i>Transmit actual value every</i>	do not send cyclically <i>3 min, 5 min, 10 min, 15 min 20 min, 30 min 60 min</i>	How often should the actual value be sent, regardless of the temperature changes?

3.4.8 E2 parameter page

This page is only available if the *Supported function* parameter is set to *Heating* (General parameter page).

Table 23

Designation	Values	Meaning
<i>Function of E2</i>	Contact closed = window closed Contact open = window closed	Type of connected contact (NC or NO)
<i>Cyclical transmission of E2 status every</i>	do not send cyclically <i>3 min, 5 min, 10 min, 15 min,</i> <i>20 min, 30 min</i> <i>60 min</i>	Cyclical transmission time for input E2

3.4.9 Drip tray monitoring parameter page

Table 24

Designation	Values	Meaning
<i>Source for drip tray monitoring</i>	E2 <i>Object 16</i>	Condensate is reported to E2 via a contact Condensate is reported to object 16 via the bus.
<i>Direction of action of E2</i>	Contact closed = Condensate Contact open = Condensate	Type of connected condensate report contact or condensate telegram.
<i>Behaviour in case of drip tray alarm</i>	Cooling off and fan off <i>Cooling off and fan step 1</i> <i>Cooling off and max. fan step</i> <i>Only report</i>	Reaction to drip tray alarm
<i>Cyclical transmission of drip tray status every</i>	do not send cyclically <i>3 min, 5 min, 10 min, 15 min</i> <i>20 min, 30 min</i> <i>60 min</i>	Cyclical transmission time for drip tray status

3.4.10 Set point adjustment *parameter page*

See appendix: [Set point adjustment](#)

Table 25

Designation	Values	Meaning
<i>Also use set point adjustment for internal control</i>	<i>yes</i>	The basic control set point (= <i>Basic set point value after reset + dead zone</i>) should be adjusted step by step in relation to the outdoor temperature.
	<i>no</i>	Set point adjustment does not influence the internal controller.
<i>Set point adjustment from</i>	25 °C, 26 °C, 27 °C 28 °C, 29 °C, 30 °C 31 °C, 32 °C, 33 °C 34 °C, 35 °C, 36 °C 37 °C, 38 °C 39 °C, 40 °C	Activation threshold for set point adjustment.
<i>Adjustment</i>	<i>None</i>	No temperature adjustment
	<i>1 K per 1 K outdoor temperature</i>	Strength of set point adjustment: At what change of outdoor temperature should the set point be adjusted by 1 K?
	<i>1 K per 1 K outdoor temperature</i>	
	1 K per 1 K outdoor temperature	
	<i>1 K per 1 K outdoor temperature</i>	
	<i>1 K per 1 K outdoor temperature</i>	
	<i>1 K per 1 K outdoor temperature</i>	
<i>1 K per 1 K outdoor temperature</i>		
<i>Format of adjustment value</i>	relative	Object 19 transmits a temperature differential in K, in relation to the outdoor temperature. This value can be used as a set point adjustment for additional room thermostats.
	<i>absolute</i>	Object 19 transmits a set point in °C (<i>basic unadjusted set point</i>). This is increased in relation to the outdoor temperature and serves as set point for additional temperature controls.

Continuation:

Designation	Values	Meaning
<i>Base unadjusted set point</i>	15 °C, 16 °C, 17 °C 18 °C, 19 °C, 20 °C 21 °C , 22 °C, 23 °C 24 °C, 25 °C, 26 °C, 27 °C, 28 °C 29 °C, 30 °C	Base set point for additional room thermostats. Important: This value should coincide with the base set point of the actuated controller.
<i>Cyclical transmission of set point adjustment every</i>	do not send cyclically 3 min, 5 min, 10 min, 15 min 20 min, 30 min 60 min	Cyclical transmission time for set point adjustment

3.4.11 Set point values *parameter page* (internal controller)

Table 26

Designation	Values	Meaning
<i>Base set point after reset</i>	15 °C, 16 °C, 17 °C 18 °C, 19 °C, 20 °C 21 °C , 22 °C, 23 °C 24 °C, 25 °C, 26 °C 27 °C, 28 °C, 29 °C 30 °C	Output set point value for temperature control.
<i>Reduction in standby operating mode (during heating)</i>	0.5 K, 1 K, 1.5 K 2 K , 2.5 K, 3 K 3.5 K, 4 K	How much should the temperature be reduced by in standby operating mode?
<i>Reduction in night mode (during heating)</i>	3 K, 4 K, 5 K 6 K, 7 K, 8 K	How much should the temperature be reduced by in night mode?
<i>Set point value for frost protection operation (during heating)</i>	3 °C, 4 °C, 5 °C 6 °C , 7 °C, 8 °C 9 °C, 10 °C	Preset temperature for frost protection operation in heating mode (Heat protection operation applies in cooling mode).
<i>Dead zone between heating and cooling</i>	1 K, 2 K , 3 K 4 K, 5 K, 6 K	Specifies the buffer zone between set point values in heating and cooling operations. See glossary: Dead zone
<i>Increasing in standby mode (during cooling)</i>	0.5 K, 1 K, 1.5 K 2 K , 2.5 K, 3 K 3.5 K, 4 K	How much should the temperature be raised by in night mode?
<i>Increase in night mode (during cooling)</i>	3 K, 4 K, 5 K 6 K, 7 K, 8 K	How much should the temperature be raised by in night mode?
<i>Set point value for heat protection (during cooling)</i>	42 °C i.e. almost no heat protection 29 °C 30 °C 31 °C 32 °C 33 °C 34 °C 35 °C	The heat protection represents the maximum permitted temperature for the controlled room. It performs the same function during cooling as the frost protection mode during heating, e.g. saves energy while prohibiting non-permitted temperatures

Continuation:

Designation	Values	Meaning
<i>Current set point value in comfort mode</i>	<p>Sends actual value (Heating < > Cooling)</p> <p><i>Transmits average value between heating and cooling</i></p>	<p>The set point value actually being controlled is always sent (= current set point value). Example with base set point of 21°C and dead zone of 2K: During heating 21°C is transmitted and during cooling base set point value + dead zone is transmitted (21°C + 2K = 23°C)</p> <p>Same value in comfort operation mode during both heating and cooling operation, i.e.: Base set point value + half dead zone are transmitted to prevent room users being irritated. Example with base set point value of 21°C and dead zone of 2K: Mean value = 21° + 1K = 22°C Although control takes place at 21°C during heating and 23°C during cooling.</p>
<i>Cyclical transmission of set point value every</i>	<p>do not send cyclically 3 min, 5 min, 10 min 15 min, 20 min, 30 min 60 min</p>	Cyclical transmission time for the current set point value

3.4.12 Operating mode and operation *parameter page* (internal controller)

Table 27

Designation	Values	Meaning
<i>Operating mode after reset</i>	<i>Frost / heat protection</i> <i>Night-time temperature reduction</i> Standby <i>Comfort</i>	Operating mode after start-up or re-programming
<i>Cyclical transmission of operating mode every</i>	do not send cyclically <i>3 min, 5 min, 10 min</i> <i>15 min, 20 min, 30 min</i> <i>60 min</i>	Cyclical transmission time of operating mode (object 24)
<i>Objects for operating mode selection</i>	new: Operating mode, presence, window status <i>old: comfort, night, frost (not recommended)</i>	FCA 1 can switch the operating mode depending on the window and presence contacts. Traditional setting without window and presence status.
<i>Type of presence detector</i>	Presence indicator <i>Presence keys</i>	The presence sensor activates comfort mode Comfort operating mode as long as the presence object is set. If the operating mode object (Object 3) is called up again after setting the presence object the new operating mode will be accepted and the presence object reset. If the presence object is set during night / frost operation, it is reset after the configured comfort extension finishes (see below). The presence object is not reported on the bus.

Continuation:

Designation	Values	Meaning
<i>Time for comfort extension</i>	30 min 1 hour 1.5 hours 2 hours 2.5 hours 3 hours 3.5 hours	How long should the controller stay in comfort operating mode after presence has been detected? (Only for presence push buttons).
<i>Limitation of manual adjustment</i>	no adjustment +/- 1 K +/- 2 K +/- 3 K +/- 4 K +/- 5 K	The set point cannot be adjusted. The set point value can be changed by the configured amount at the most (object 25)

3.4.13 Regulation *parameter page* (internal controller)

Table 28

Designation	Values	Meaning
<i>Sets the control parameters</i>	Standard <i>User-defined</i>	For standard use. The control parameters are preset. Professional application: The control parameters can be individually adjusted. See appendix: Temperature control
<i>User-defined parameters</i>	<i>Proportional band of heating control</i>	Professional setting to adapt the control response to the room. Small values cause large changes in actuating values, larger values cause finer actuating value adjustment. Standard value: 4 K
	<i>Integrated time of heating control</i>	<i>Pure P control</i> 15 min., 30 min., 45 min., 60 min., 75 min., 90 min. 105 min, 120 min 135 min, 150 min 165 min, 180 min 195 min., 210 min. 225 min

Continuation:

Designation	Values	Meaning	
User-defined parameters	<i>Proportional band of the cooling control</i>	<p>Pure P control</p> <p>1 K, 1.5 K, 2 K 2.5 K, 3 K, 3.5 K 4 K, 4.5 K, 5 K 5.5 K, 6 K, 6.5 K 7 K, 7.5 K, 8 K 8.5 K</p>	<p>Only proportional controller. See appendix: Temperature control</p> <p>Professional setting to adapt the control response to the room. Large values cause finer changes to the actuating value with the same control deviation and more precise control than smaller values. Standard value: 4 K</p>
	<i>Integrated time of the cooling control</i>	<p>Pure P control</p>	<p>Only proportional controllers. See appendix: Temperature control</p>
		<p>15 min., 30 min., 45 min., 60 min., 75 min., 90 min. 105 min, 120 min 135 min, 150 min 165 min, 180 min 195 min., 210 min. 225 min</p>	<p>For PI control only: The integrated time determines the reaction time of the control. These times can be adapted to suit particular circumstances. If the cooling system is over-dimensioned and therefore too fast, shorter values should be used. Conversely, under-dimensioned cooling (slow) benefits from longer integrated times. Standard value: 90 min</p>
<i>Switchover between heating and cooling</i>	<p>automatic</p> <p><i>via object</i></p>	<p>FCA 1 automatically switches to cooling mode when the actual temperature is above the set point value.</p> <p>Cooling mode can only be activated on the bus via object 28 (1=cooling). Cooling mode remains off for as long as this object is not set (=0).</p>	

Continuation:

Designation	Values	Meaning
<i>Transmission of actuating value</i>	<i>on change of 1 %</i> <i>on change of 2 %</i> <i>on change of 3 %</i> <i>on change of 5 %</i> <i>on change of 7 %</i> <i>on change of 10 %</i> <i>on change of 15 %</i>	After what percentage change* in the actuating value is the new value to be transmitted?
<i>Cyclical transmission of actuating values every</i>	<i>do not send cyclically</i> <i>3 min, 5 min, 10 min</i> <i>15 min, 20 min, 30 min</i> <i>60 min</i>	Cyclical transmission time for actuating value.
<i>Report, when cooling required but cooling disabled</i>	<i>Only if object value = 1</i> <i>Always cyclically</i>	With <i>Supported function = cooling</i> Transmit error message with object if cooling should be activated because of the temperature but cooling is not enabled (object 1).
<i>Report, if heating required but heating disabled</i>	<i>Only if object value = 1</i> <i>Always cyclically</i>	with <i>Supported function = heating</i> Transmit error message with object 29 if heating should be activated because of the temperature but heating is not enabled (object 1).
<i>Report, when no energy medium</i>	<i>Only if object value = 1</i> <i>Always cyclically</i>	with <i>Supported function = heating and cooling</i> Error message if heating or cooling should be activated because of the temperature and status of „ <i>Heating/cooling switch</i> object conflicts with this (for 2-pipe, object 1. With 4-pipe, object 28 when switching between heating and cooling via object).
<i>Report cyclically</i>	<i>every 3 min, 5 min, 10 min</i> <i>15 min, 20 min, 30 min</i> <i>60 min</i>	Cyclical transmission time for energy medium error message

*Change since last transmission

3.4.14 Filter monitoring parameter page

This parameter page is only visible if this function has been selected on the *General* parameter page (parameter: *If a filter change is reported*).

Table 29

Designation	Values	Meaning
Report filter change after fan operation (1..127 weeks)	manual input: 1..127 (Standard 12)	interval between 2 filter changes in weeks.
Cyclical transmission of filter change	only at filter change <i>always cyclically</i>	Object 31 only sends when filter change is required: 1 = Change filter Object 31 sends the filter status cyclically: 0 = Filter OK 1 = Change filter
Transmit fan duty time* (in hours)	never transmit (reading is possible) <i>only at change</i> <i>cyclically and at change</i>	The fan duty time is counted to the second internally, but not transmitted. The counter reading can be read from object 30. The counter reading is transmitted every time the fan duty time increases by 1 hour. The counter reading is transmitted at regular intervals and at changes.
Send cyclically	<i>every 3 min., every 5 min.</i> <i>every 10 min., every 15 min.</i> <i>every 20 min., every 30 min.</i> <i>every 45 min., every 60 min.</i>	Cyclical transmission time for counter reading.

* To reset the filter status and the counter reading, see [object 31](#).

3.4.15 Actuating value loss parameter page

This parameter page is only visible if an external controller is used and if the function has been selected on the *General* parameter page (parameter: *If the actuating value is monitored*).

Table 30

Designation	Values	Meaning
<i>Monitoring time for actuating value</i>	<i>30 min</i> <i>60 min</i>	If no actuating value is received within the configured time, the substitute activating value applies.
<i>Substitute actuating value (emergency program)</i>	<i>0 %, 10 %, 20 %</i> <i>30 %, 40 %, 50 %, 60 %,</i> <i>70 %, 80 %, 90 %, 100 %</i>	Actuating value for the emergency program provided no new actuating value is received by room temperature controller.
<i>Report actuating value loss cyclically (1 = actuating value loss)</i>	<i>only if object value = 1</i> <i>always cyclically</i>	Object 20 only transmits at actuating loss. Object 20 always transmits the status of actuating value. 0 = OK 1 = Actuating value loss
<i>Report cyclically</i>	<i>every 3 min., every 5 min.</i> <i>every 10 min., every 15 min.</i> <i>every 20 min., every 30 min.</i> <i>every 45 min., every 60 min.</i>	Cycle time for actuating value status.

4 Start-up

4.1 Test mode

Test mode serves to check the system, e.g. during commissioning or during troubleshooting.

In this mode, the valves and the fans can be set by hand as required using the appropriate keys. A temperature sensor (Order nr. 907 0 321) and/or the window contacts can also be checked.

Important information about the test mode:

- Both the control and the bus telegrams are ineffective.
- All settings are possible without any restrictions.
- The valves are actuated until they are switched off again by hand.
- Condensate alarm is not taken into account.
- **The prevention of improper operating conditions (e.g. heating and cooling valves are open simultaneously or a valve is permanently supplied with power, etc.) is the responsibility of the user.**

Allow / suppress test mode:

The test mode is allowed or suppressed via the *Test mode after reset* parameter on the *General* parameter page.

Activate test mode:

Reset, i.e. via download or bus voltage application:

→ The test mode LED flashes for 1 minute.

During this time, the test mode can be started by pressing the valve (⌘/⌘) or fan button(⌘). The FCA 1 → switches to test mode and the "test" LED is permanently illuminated.

End test mode:

The test mode can be ended by simultaneously pressing both buttons or reset.

If no buttons are pressed while the test mode LED is flashing, the FCA 1 automatically moves to normal operating mode after one minute.

At initial start-up, i.e. no application program, the LED flashes without time limit.

Operation:

- Fan control:

The following operating conditions are accepted in sequence if button A (fan) is pressed.

Table 31

Keystroke	Function	LED
1	Fan step 1	S1 on
2	Fan step 2	S2 on
3	Fan step 3	S3 on
4	Fan off	S1-S3 off

- Control valves, switch on auxiliary relay:

The following operating conditions are accepted in sequence if button B (valves) is pressed.

Table 32

Keystroke	LED	Output
1	Cooling LED on	After 2 sec V2+ on
2	Cooling LED flashes	After 2 sec V2- on
3	Heating LED on	After 2 sec V1+ on
4	Heating LED flashes	After 2 sec V1- on
5	LED C1 on	After 2 sec C1 on
6	All LEDs off	All outputs off

Via the delayed switching of the outputs the user can skip the individual modes without altering the valve position by quickly pressing the buttons.

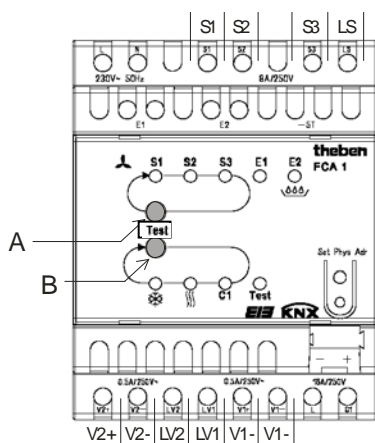



Figure 2

Table 33: Status display, heating and cooling valve

LED	Status	Meaning	
		with 3-way valves	with 2-way valves
	is OFF	Cooling valve is not actuated	Cooling valve is not actuated
	is ON	Cooling valve is opened (C+)	Cooling valve is opened (C+)
	Flashing	Cooling valve is closed (C-)	Cooling valve is closed (i.e. is no longer actuated).
	is OFF	heating valve is not actuated	heating valve is not actuated
	is ON	Heating valve is opened (H+)	Heating valve is opened (C+)
	Flashing	Heating valve is closed (H-)	Heating valve is closed (i.e. is no longer actuated).

Checking the temperature sensor:

If a temperature sensor is connected to input E1, and E1 is configured accordingly in the application, the measured room temperature is transmitted by object 14.

A sensor break or short-circuit in the sensor line are reported by the value -60 °C.

Checking the window contacts:

If a window contact is connected to input E1 and E1 is configured accordingly in the application, the window status is sent to the configured group address (object 14).

Likewise, input E2 can be checked (object 16, drip tray monitoring or window contact).

Behaviour in delivery condition:

Before the application software is downloaded for the first time, inputs E1, E2 and the auxiliary relay C1 are connected via a common group address:

E1 = 7/4/100

E2 = 7/4/101

C1 = 7/4/100, 7/4/101

If the contact is connected to E1 or E2, the auxiliary relay C1 is switched on.

This allows both inputs to be checked without bus monitor.

Exit test mode

Test mode is closed with a reset, i.e.:

- by simultaneously pressing both buttons (A+B)
- by downloading the application
- by interrupting and resetting the bus voltage

4.2 Device LEDs in automatic mode

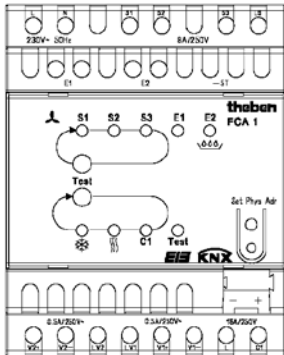

Figure 3

LED	Function	Explanation
S1	Fan step 1	Lights up if fan step 1 is active (<i>Starting strategy</i> is not taken into account).
S2	Fan step 2	Lights up if fan step 2 is active (<i>Starting strategy</i> is not taken into account).
S3	Fan step 3	Lights up if fan step 3 is active (<i>Starting strategy</i> is not taken into account).
❄	Cooling	Lights up if the cooling valve is open. Flashes if opening of the cooling valve is delayed, because the heating valve is not completely closed or the <i>time between heating and cooling</i> has run out.
☺	Heating	Lights up if the heating valve is open. Flashes if opening of the heating valve is delayed, because the cooling valve is not completely closed or the <i>time between heating and cooling</i> has run out.
C1	Auxiliary relay	Lights up if the auxiliary relay is switched on.
Test	Test mode	Flashes after reset if <i>test mode</i> is selected or if the device has not been programmed. Lights up if the device is in <i>test mode</i> .
E1	Input 1	When used as a <i>window contact</i> : Lights up if contact is closed. When used as an <i>actual value sensor</i> : Stays off in normal temperature range (i.e. -10 °C .. 60 °C). Flashes with interruption or short-circuit in the sensor line and temperatures outside the normal range.
E2	Input 2	For use as a <i>window contact</i> (only with <i>supported function = heating or ventilation</i>) : Lights up if contact is closed. With <i>supported function = heating and cooling or cooling</i> : Flashes at drip tray alarm, regardless of <i>source for drip tray monitoring</i> .

4.3 Mains power failure detection for 3-Point valves

In case of mains power failure during the positioning of a 3-point valve, this one would stay in an undefined position after power reset.

Therefore the tension at the L and N connection terminals is monitored and the 3-point valves will be closed after power reset. Afterwards, a new positioning will be started.

Important:

This feature is only available if the valves and the FCA 1 are part of the same circuit.

5 Typical applications:

5.1 Base configuration (4-pipe system): Heating and cooling with fan coil with remote controller

The FCA 1 is actuated via a RAM 713 FC room thermostat.

5.1.1 Devices:

- FCA 1
- RAM 713 FC

5.1.2 Overview

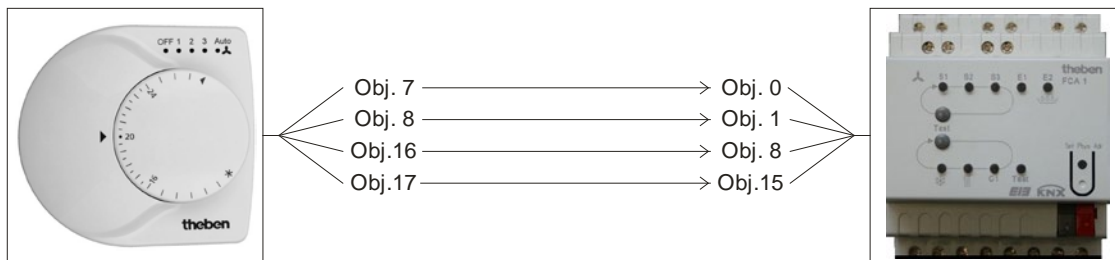

Figure 4

5.1.3 Objects and links

Table 34: Links

No.	RAM 713 FC	No.	FCA 1	Comments
	Object name		Object name	
7	<i>Actuating value heating</i>	0	<i>Actuating value heating</i>	FCA receives the heating and cooling actuating values from RAM 713 S
8	<i>Actuating value cooling</i>	1	<i>Actuating value cooling</i>	
16	<i>Forced fan step</i>	8	<i>Forced fan step</i>	% value for forced mode
17	<i>Manual mode/auto mode</i>	15	<i>Fan Manual= 1 / Auto = 0</i>	Trigger for manual mode

5.1.4 Important parameter settings

The standard parameter settings apply for unlisted parameters.

Table 35: FCA 1

Parameter page	Parameters	Setting
<i>General</i>	<i>Supported function</i>	<i>Heating and cooling</i>
	<i>System type</i>	<i>4-pipe system</i>
	<i>Type of controller used</i>	<i>remote controller</i>
<i>Heating valve</i>	<i>Type of valve</i>	<i>2-point</i>
<i>Cooling valve</i>	<i>Type of valve</i>	<i>2-point</i>

Table 36: RAM 713 FC

Parameter page	Parameters	Setting
<i>Settings</i>	<i>Device type</i>	<i>RAM 713 Fan Coil</i>
<i>Control</i>	<i>Fan coil system used</i>	<i>4-pipe system</i>
<i>Operating mode</i>	<i>Objects for determining the operating mode</i>	<i>old: Comfort, night, frost</i>

5.2 Base configuration (2-pipe system): Heating and cooling with fan coil with remote controller

5.2.1 Devices:

- FCA 1
- RAM 713 FC

5.2.2 Overview

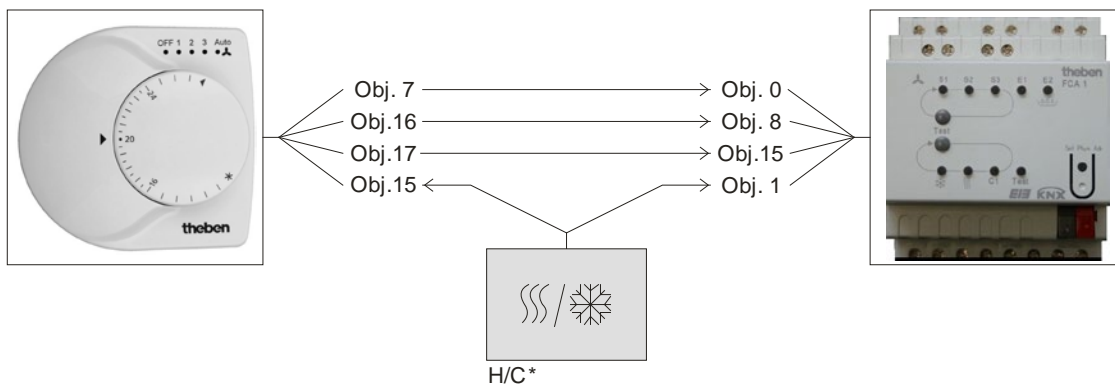

Diagram 5

* H/C = heating / cooling system

5.2.3 Objects and links

Table 37: Links

No.	RAM 713 FC	No.	FCA 1	Comments
	Object name		Object name	
7	<i>Actuating value heating and cooling</i>	0	<i>Actuating value heating/cooling</i>	FCA receives the heating and cooling actuating values from RAM 713 FC
15	<i>Switchover between heating and cooling</i>	1	<i>Switchover between heating and cooling</i>	Telegram is produced by the heating/cooling system
16	<i>Forced fan step</i>	8	<i>Forced fan step</i>	% value for forced mode
17	<i>Manual/auto mode</i>	15	<i>Manual/auto mode</i>	Trigger for forced mode

5.2.4 Important parameter settings

The standard parameter settings apply for unlisted parameters.

5.2.4.1 FCA 1

Table 38

Parameter page	Parameters	Setting
<i>General</i>	<i>Supported function</i>	<i>Heating and cooling</i>
	<i>System type</i>	<i>2-pipe system</i>
	<i>Type of controller used</i>	<i>remote controller</i>
<i>Heating/cooling valve</i>	<i>Type of valve</i>	<i>2-point</i>

5.2.4.2 RAM 713 FC

Table 39

Parameter page	Parameters	Setting
<i>Settings</i>	<i>Device type</i>	<i>RAM 713 Fan Coil</i>
<i>Control</i>	<i>Fan coil system used</i>	<i>2-pipe system</i>
<i>Operating mode</i>	<i>Objects for determining the operating mode</i>	<i>new: Operating mode, presence, window status</i>

5.3 Typical application (4-pipe system):

5.3.1 Function:

- A heating and cooling system is installed in an office building with separate circuits for hot and cold water.
- The room temperature in the individual offices is to be controlled according to the time of day and level of occupation.
- On hot summer days less cooling is to be used to save energy.
This improves the level of comfort for the office users as this prevents too extreme a temperature difference when leaving the office.

5.3.2 Devices:

- FCA 1
- RAM 713 FC
- TR 644 S
- Presence indicator
- Weather station

5.3.3 Overview

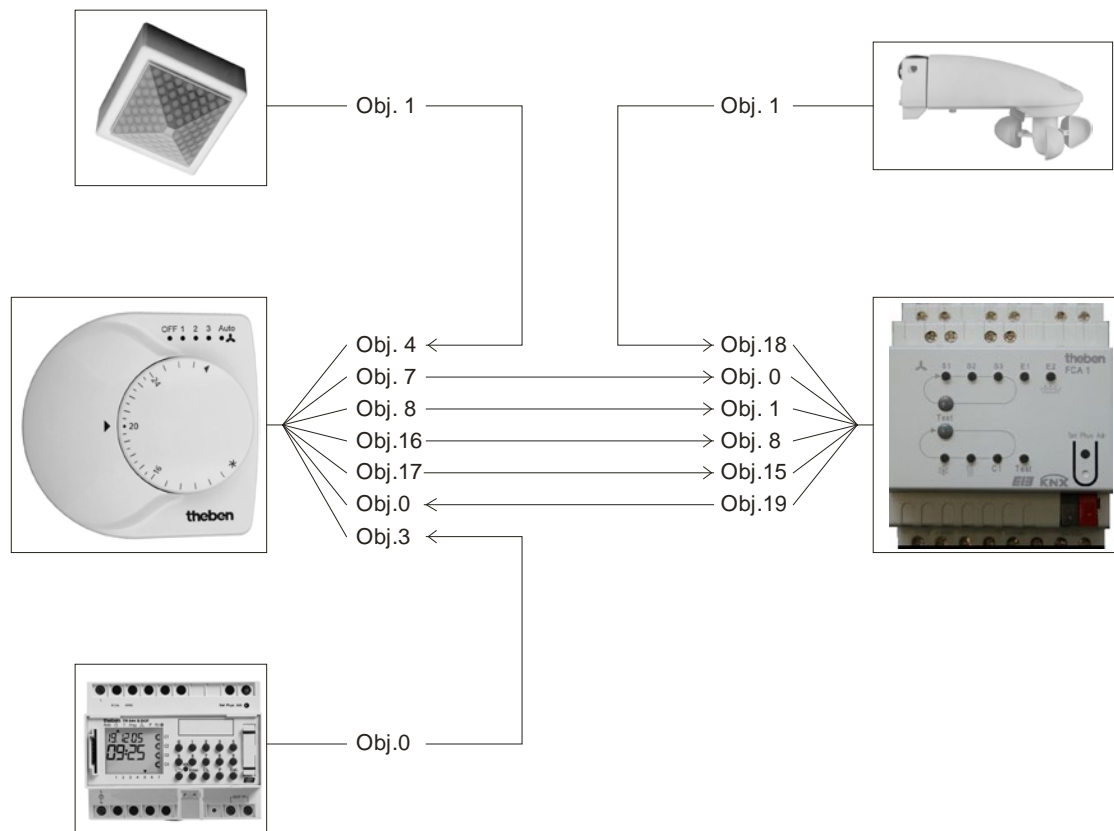

Figure 6

5.3.4 Implementation:

A RAM 713 FC and an FCA 1 are used for room temperature control.

The RAM 713 calculates the set point value based on the selected operating mode and a set point adjustment by the room user.

The operating mode is specified by a TR 644 EIB timer.

On working days the timer switches, just before work starts, to *standby* and at the end of the working day to *night mode*.

In addition, one channel on the timer is connected to the operating mode object of the controller.

A presence detector allows the activation of *comfort mode* if the office is actually occupied. In addition, the presence detector is connected to the presence object of the controller.

The room thermostat is connected to the FCA 1 via the *actuating value heating* and *actuating value cooling* objects.

The FCA 1 controls the valves and the fan in the *auto* position via these objects.

Manual setting of fan steps requires the connection of objects 8 and 15 of FCA 1 with objects 16 and 17 of the RAM 713 FC.

The outside temperature is sent from a weather station to the FCA 1 (object 18) for adjustment of the set point value on hot summer days.

This determines, depending on the configuration, the set point adjustment transmitted to the room thermostat.

Objects 19 (FCA 1) and object 0 (RAM 713 S) are connected with each other for this purpose.

Objects and links

Table 40: Temperature controller links with the fan coil actuator.

No.	RAM 713 FC	No.	FCA 1	Comments
	Object name		Object name	
7	<i>Actuating value heating</i>	0	<i>Actuating value heating</i>	FCA receives the actuating value heating from RAM 713 S
8	<i>Actuating value cooling</i>	1	<i>Actuating value cooling</i>	FCA receives the actuating value cooling from RAM 713 S
16	<i>Forced fan step</i>	8	<i>Forced fan step</i>	% value for forced mode
17	<i>Manual/auto mode</i>	15	<i>Manual/auto mode</i>	enables the manual selection of fan step on the RAM 713 FC
0	<i>Manual set point adjustment</i>	19	<i>Adjust set point</i>	For set point adjustment in cooling operating mode

Table 41: Weather station links with the fan coil actuator.

No.	Weather station	No.	FCA 1	Comments
	Object name		Object name	
1	<i>Temperature value</i>	18	<i>Outside temperature</i>	Outdoor temperature for set point adjustment

Table 42: Presence detector links with room temperature controller.

No.	ECO-IR	No.	RAM 713 FC	Comments
	Object name		Object name	
1	<i>HVAC switch output</i>	4	<i>Presence</i>	Presence signal for switch to comfort mode

Table 43: Timer links with room temperature controller.

No.	TR 644 S EIB	No.	RAM 713 FC	Comments
	Object name		Object name	
0	<i>Channel 1 - valuator</i>	3	<i>Operating mode preset</i>	Switches to HVAC operating mode* depending on the time of day.

* HVAC operating modes: 1 = Comfort
 2 = Standby
 3 = Night
 4 = Frost / heat protection

5.3.5 Important parameter settings

The standard parameter settings apply for unlisted parameters.

Table 44: FCA 1

Parameter page	Parameters	Setting
<i>General</i>	<i>Supported function</i>	<i>Heating and cooling</i>
	<i>Heating system</i>	<i>Fan coil</i>
	<i>Cooling system</i>	<i>Fan coil</i>
	<i>System type</i>	<i>4-pipe system</i>
	<i>Type of controller used</i>	<i>remote controller</i>
<i>Heating valve</i>	<i>Type of valve</i>	<i>2-point</i>
<i>Cooling valve</i>	<i>Type of valve</i>	<i>2-point</i>
<i>Set point adjustment</i>	<i>Set point adjustment from</i>	<i>25 °C</i>
	<i>Adjustment</i>	<i>1 K per 1 K outdoor temperature</i>
	<i>Format of adjustment value</i>	<i>relative</i>

Table 45: RAM 713 FC

Parameter page	Parameters	Setting
<i>Settings</i>	<i>Device type</i>	<i>RAM 713 Fan Coil</i>
<i>Operation</i>	<i>Function of the rotary control</i>	<i>Manual adjustment with report object</i>
<i>Control</i>	<i>Fan coil system used</i>	<i>4-pipe system</i>
	<i>Switchover between heating and cooling</i>	<i>automatic</i>
<i>Operating mode</i>	<i>Objects for determining the operating mode</i>	<i>new: Operating mode, presence, window status</i>

Table 46: Weather station

Parameter page	Parameters	Setting
<i>Measured values</i>	<i>Transmit temperature in the event of change of</i>	<i>1.0°C</i>

Table 47: TR 644 S EIB timer

Parameter page	Parameters	Setting
<i>Channel 1</i>	<i>Object type</i>	<i>Valuator</i>
	<i>Value when clock is switched on</i>	<i>2*</i>
	<i>Value when clock is switched off</i>	<i>3**</i>

* Standby

** Night

Table 48: Presence detector (e.g. Eco-IR 180, 360 or Compact Office*)

Parameter page	Parameters	Setting
<i>General information</i>	<i>Normal or test operating mode</i>	<i>Normal operation</i>
	<i>HVAC switch output*</i>	<i>Active</i>
<i>HVAC switch output</i>	<i>behaviour at start/end of HVAC requirement</i>	<i>Transmit on and off telegram</i>

* Presence output

6 Appendix

6.1 Monitoring actuating value

6.1.1 Application

Should the remote room temperature controller (RTR) fail, despite the last sent actuating value being 0%, all valves remain closed, irrespective of the continued temperature characteristic curve. This can result in considerable damage, if for example, cold air enters the room when the ambient temperature is below zero.

To avoid this situation, FCA 1 is able to guarantee the following functions:

1. monitor the correct function of the room thermostat
2. start an emergency program on actuating value failure
3. transmit the status obtained from actuating value monitoring

6.1.2 Principle

FCA 1 drive monitors whether, within the configured time value, at least 1 actuating value telegram is received and assumes a pre-defined actuating value should the actuating value fail.

6.1.3 Practice

The RTR is configured for cyclical transmission of the actuating value.

On the FCA 1, the monitoring time is set to a value that is at least twice the cycle time of the RTR.

If the RTR transmits an actuating value every 15 minutes, the monitoring time must be at least 30 minutes.

After an actuating value loss, normal operation is resumed as soon as a new actuating value is received.

If the disable function is activated (object 1: *disable heating* = 1 or *enable cooling* = 0) only the actuating value loss telegram is transmitted.

The relevant valve remains/is closed and assumes the configured emergency program actuating value once the lock is removed.

6.2 Set characteristic valve curve

The parameters on the *heating valve* and *cooling valve* pages enable exact adjustment to the available valve type or enable the adjustment of the control.

Example for a valve that starts to open from a position of 10% and is completely open by 80%.

Figure 7

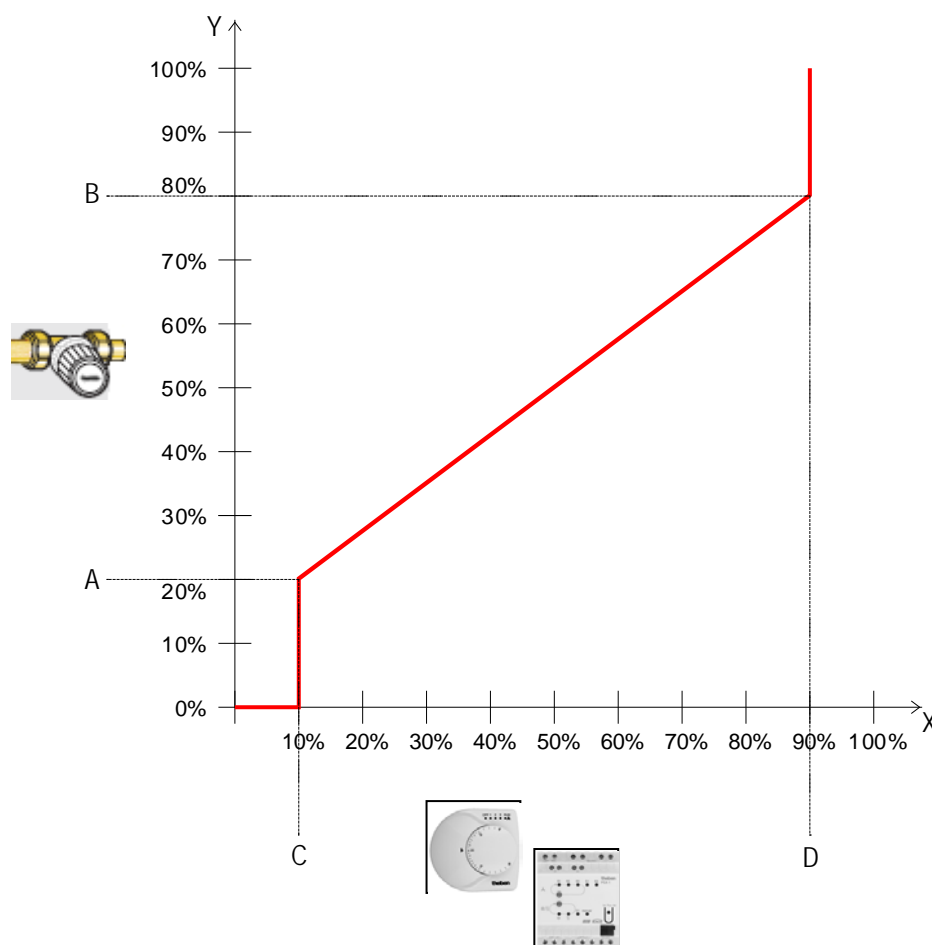

Table 49

	Description	Value
X	Actuating value of the controller	0 .. 100 %
Y	Resulting valve position	0 .. 100 %
A	Parameters: Minimum valve position*	20 %
B	Parameters: Maximum valve position	80%
C	Parameters: Open from actuating value	10 %
D	Parameters: Maximum valve position from actuating value	90 %

6.3 Set point adjustment

The current set point can be adjusted via object 25 "*manual adjustment*" by up to +/- 5 K

With every alteration, the adjusted set point is transmitted by the *current set point value* object (object 27).

The limits of the adjustment are set on the *operating mode and operation parameter page* with the *limitation of manual adjustment* parameter.

6.4 Set point adjustment

The set point adjustment enables a dynamic adjustment of the set point to the outdoor temperature when cooling.

If the outdoor temperature exceeds a set threshold, adjustment is activated and a relevant increase of the set point is calculated.

6.4.1 Use with an internal controller

The set point adjustment can be applied to the internal controller, if the *use set point adjustment for control* parameter is set to yes.

In this case the set point value of the internal controller (*Base set point after reset*) is always relatively adjusted, i.e. increased or decreased by the calculated adjustment value (see figure 2 below).

Moreover, an independent set point value can be produced, which makes adjustment available for other controllers in the building (see below: [Format of set point adjustment: Absolute](#)).

6.4.2 Use with a remote controller

There are 2 types of set point adjustment available for remote controllers, the relative and absolute.

See also: [Set point adjustment parameter page](#).

6.4.3 Format of set point adjustment: Relative

Set point adjustment is sent from object 19 as a temperature differential. Provided the set point adjustment threshold (*set point adjustment from*) has not been reached, the value 0 is sent. If the set point value threshold is exceeded, the value is increased each time by 1 K if the outdoor temperature has risen above the configured value (*adjustment*). Object 19, *adjust set point*, is typically linked to the *manual set point adjustment* object of the room thermostat.

Example: Transmitted adjustment value

Set point adjustment from: 25 °C

Figure 8: Set point adjustment dependent on outdoor temperature

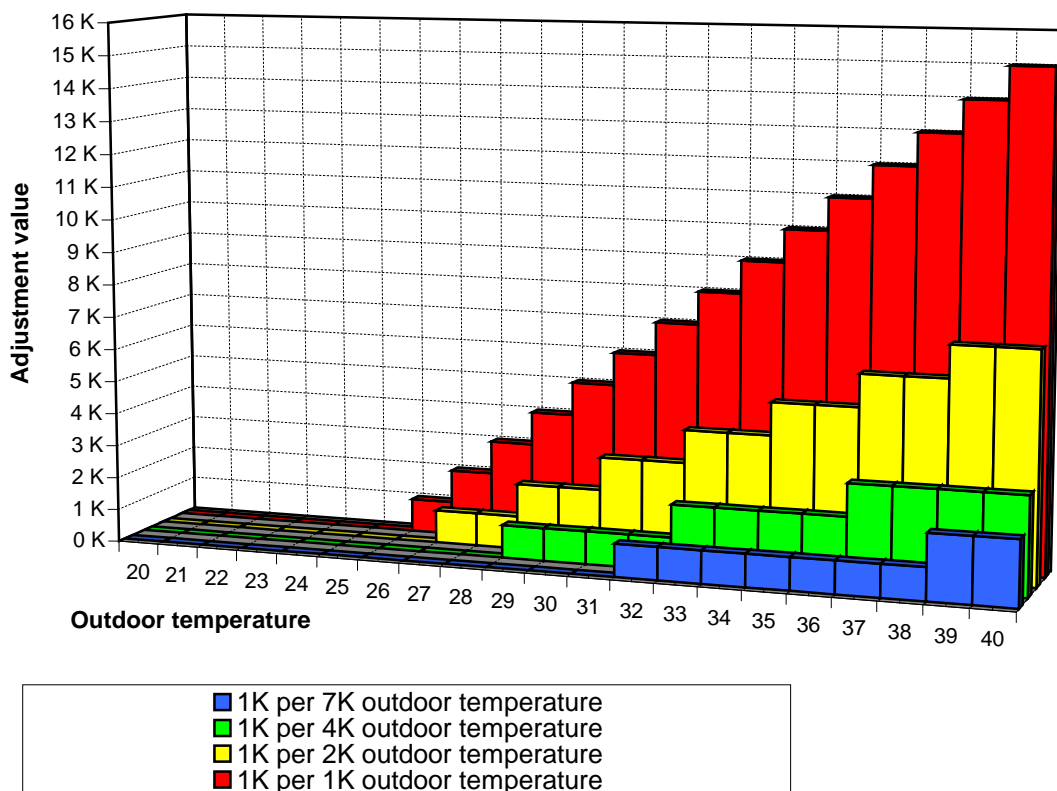

Table 50: Adjustment values

Outdoor temperature	1K/1K	1K/2K	1K/3K	1K/4K	1K/5K	1K/6K	1K/7K
20	0 K	0 K	0 K	0 K	0 K	0 K	0 K
21	0 K	0 K	0 K	0 K	0 K	0 K	0 K
22	0 K	0 K	0 K	0 K	0 K	0 K	0 K
23	0 K	0 K	0 K	0 K	0 K	0 K	0 K
24	0 K	0 K	0 K	0 K	0 K	0 K	0 K
25	0 K	0 K	0 K	0 K	0 K	0 K	0 K
26	1 K	0 K	0 K	0 K	0 K	0 K	0 K
27	2 K	1 K	0 K	0 K	0 K	0 K	0 K
28	3 K	1 K	1 K	0 K	0 K	0 K	0 K
29	4 K	2 K	1 K	1 K	0 K	0 K	0 K
30	5 K	2 K	1 K	1 K	1 K	0 K	0 K
31	6 K	3 K	2 K	1 K	1 K	1 K	0 K
32	7 K	3 K	2 K	1 K	1 K	1 K	1 K
33	8 K	4 K	2 K	2 K	1 K	1 K	1 K
34	9 K	4 K	3 K	2 K	1 K	1 K	1 K
35	10 K	5 K	3 K	2 K	2 K	1 K	1 K
36	11 K	5 K	3 K	2 K	2 K	1 K	1 K
37	12 K	6 K	4 K	3 K	2 K	2 K	1 K
38	13 K	6 K	4 K	3 K	2 K	2 K	1 K
39	14 K	7 K	4 K	3 K	2 K	2 K	2 K
40	15 K	7 K	5 K	3 K	3 K	2 K	2 K

6.4.4 Format of set point adjustment: Absolute

Object 19 transmits the adjusted set point value to the bus for additional room thermostats. It is typically linked to the room thermostat *base set point value* object.

This set point value consists of:
Unadjusted base set point + dead zone + adjustment.

Example:

Set point adjustment from: 25 °C, unadjusted base set point : 21 °C, dead zone = 2 K

Figure 9: Set point adjustment dependent on outdoor temperature

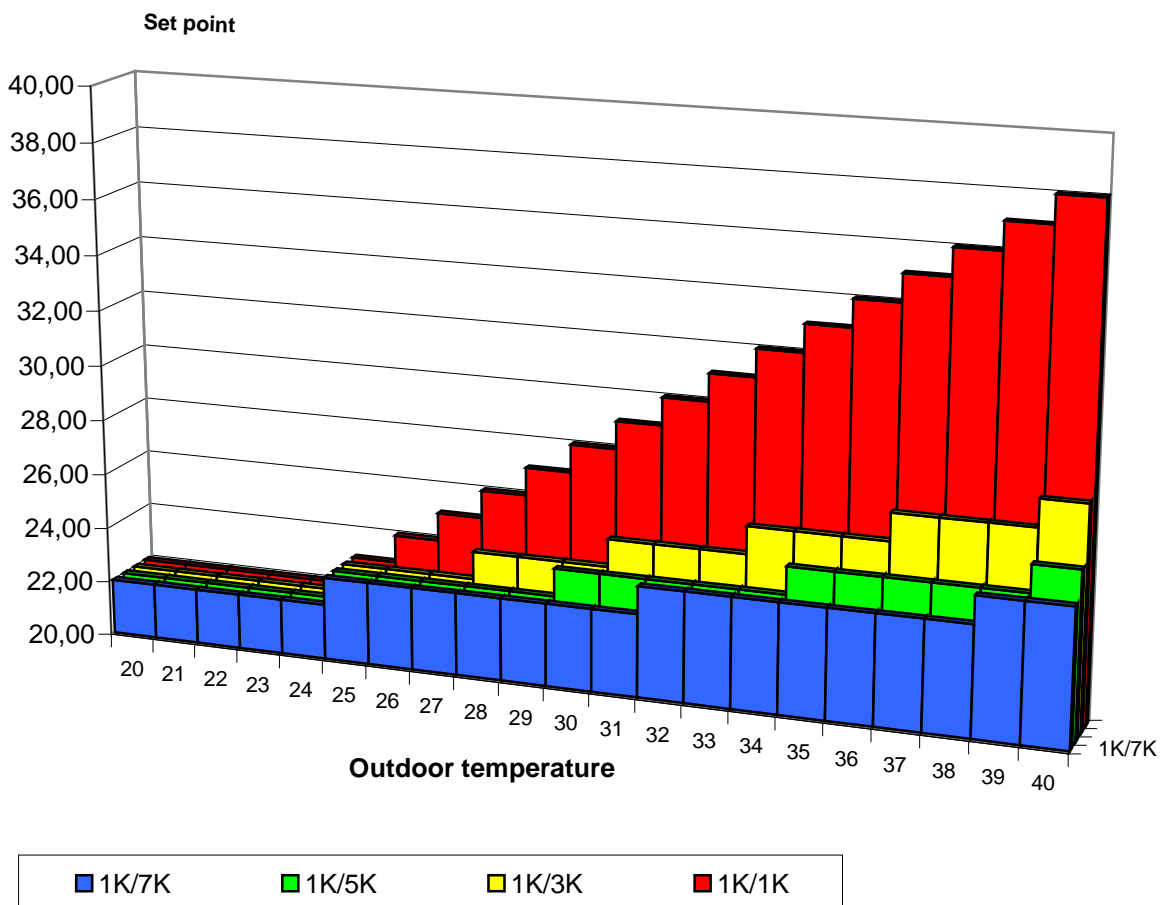

Table 51: Set point values

Outdoor temperature	1K/1K	1K/2K	1K/3K	1K/4K	1K/5K	1K/6K	1K/7K
20	22,00	22,00	22,00	22,00	22,00	22,00	22,00
21	22,00	22,00	22,00	22,00	22,00	22,00	22,00
22	22,00	22,00	22,00	22,00	22,00	22,00	22,00
23	22,00	22,00	22,00	22,00	22,00	22,00	22,00
24	22,00	22,00	22,00	22,00	22,00	22,00	22,00
25	23,00	23,00	23,00	23,00	23,00	23,00	23,00
26	24,00	23,00	23,00	23,00	23,00	23,00	23,00
27	25,00	24,00	23,00	23,00	23,00	23,00	23,00
28	26,00	24,00	24,00	23,00	23,00	23,00	23,00
29	27,00	25,00	24,00	24,00	23,00	23,00	23,00
30	28,00	25,00	24,00	24,00	24,00	23,00	23,00
31	29,00	26,00	25,00	24,00	24,00	24,00	23,00
32	30,00	26,00	25,00	24,00	24,00	24,00	24,00
33	31,00	27,00	25,00	25,00	24,00	24,00	24,00
34	32,00	27,00	26,00	25,00	24,00	24,00	24,00
35	33,00	28,00	26,00	25,00	25,00	24,00	24,00
36	34,00	28,00	26,00	25,00	25,00	24,00	24,00
37	35,00	29,00	27,00	26,00	25,00	25,00	24,00
38	36,00	29,00	27,00	26,00	25,00	25,00	24,00
39	37,00	30,00	27,00	26,00	25,00	25,00	25,00
40	38,00	30,00	28,00	26,00	26,00	25,00	25,00

6.5 Frost protection (or heat protection) via window contact

6.5.1 with remote controller:

The window contact is connected to E1. The window status is transmitted to the bus by object 14 as a command to the remote controller.

This can change automatically in frost or heat protection mode when a window is opened.

The *function of E1* parameter on the *E1* parameter page must be *E1 = window contact*.

6.5.2 with internal controller:

This function is only possible if the *objects for operating mode selection* parameter on the *operating mode and operation* parameter page is set to *new: Operating mode, presence, window status*.

The information "*window is open*" can be recorded in two ways:

- The window contact is connected to a binary input (e.g. BMG 6 *) and the window status is received on object 23.
- The window contact is connected to E2 (only possible with *supported function = heating*).

Important: The corresponding switch object (object 16 *status E2*) must be connected via the group address with object 23 (*window contact input*).

FCA 1 will recognise the opening of a window and independently change to frost protection mode (heat protection mode).

When the window is closed the previously set operating mode will be restored.

* Order no. : 491 0 230

6.6 Dead zone

The dead zone is a buffer area between heating and cooling operation. Neither heating nor cooling takes place within this dead zone.

Without this buffer zone, the system would switch continuously between heating and cooling. As soon as the set point value has been under-run, the heating is activated and the set point value would not be achieved. If cooling were then to be started immediately, the temperature would fall below the set point value and switch on the heating again.

6.7 Determining the current operating mode

The current setpoint value can be adjusted to the relevant requirements via the choice of operating mode.

The operating mode can be set via objects 21 .. 23.

There are two methods available:

6.7.1 New operating modes

If, on the parameter page, new operating mode is selected by the “Determining operating mode” parameter, the current operating mode can be defined as follows:

Table 52

Operating mode preset Object 21	Presence Object 22	Window status Object 23	current operating mode (Object 24)
any	any	1	frost / heat protection
any	1	0	comfort
comfort	0	0	comfort
standby	0	0	standby
night	0	0	night
frost / heat protection	0	0	frost / heat protection

Typical application:

In the mornings, object 21 activates “standby” or “comfort” mode and in the evenings “night” mode via a timer (e.g. TR 648).

During holiday periods, Object 21 also selects frost / heat protection via another channel on the timer.

Object 22 is connected to a presence detector. If a presence is detected FCA 1 switches to comfort operating mode (see table).

Object 23 is connected to a window contact via the bus (binary inputs).

As soon as a window is opened, FCA 1 switches to frost protection mode.

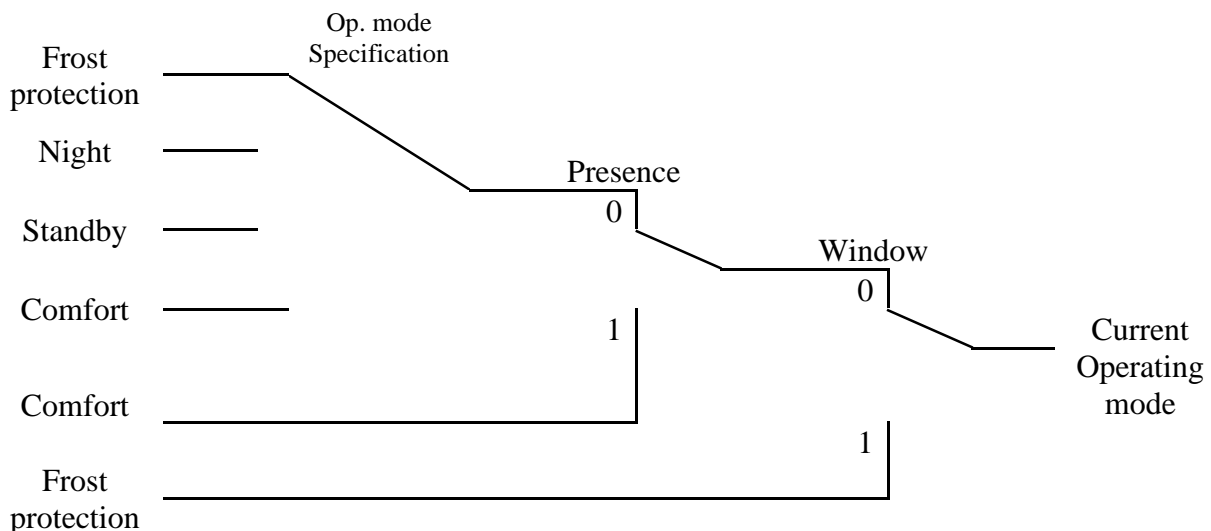

Figure 10

6.7.2 Old operating modes

If, on the parameter page, old operating mode is selected by the “determining operating mode” parameter, the current operating mode can be defined as follows:

Table 53

Night Object 21	Comfort Object 22	Object 23 frost/heat protection	current operating mode Object 24
any	any	1	frost / heat protection
any	1	0	comfort
standby	0	0	standby
night	0	0	night

Typical application: In the mornings, "standby" mode, and in the evenings "night" mode are activated via a timer via object 21.

During holiday periods, object 23 selects frost / heat protection via another channel. Object 22 (comfort) is connected to a presence detector. If a presence is detected, FCA 1 switches to comfort mode (see table). Object 23 is connected to a window contact. As soon as a window is opened, FCA 1 switches to frost protection mode.

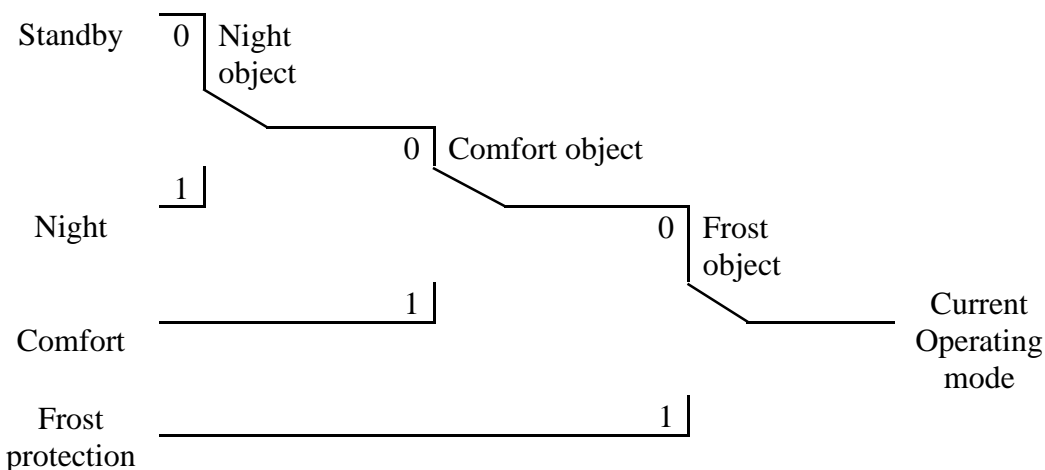

Figure 11

The old method has two advantages over the new method:

- To switch from comfort to night operating mode, 2 telegrams (2 timer channels if necessary) are required. Object 4 must be set to "0" and object 3 to "1".
- If during periods when “frost / heat protection” is selected via the timer, the window is opened and then closed again, the “frost / heat protection” mode is cleared.

6.7.3 Determining the setpoint value

6.7.3.1 Calculating the set point value in heating operation

Table 54: Current set point value during heating

Operating mode	Current set point value
Comfort	Basestlpoint value* +/- set point adjustment
Standby	Base set point* +/- set point adjustment – reduction in standby mode
Night	Base set point +/- set point adjustment – reduction in night mode
Frost / heat protection	configured set point for frost protection mode

* *Base set point after reset*

Example:

Heating in comfort mode.

Table 55: Parameter settings:

Parameter page	Parameters	Setting
<i>Set point values</i>	Base set point after reset	21 °C
	Reduction in standby mode (during heating)	2 K
<i>Operating mode and operation</i>	Limitation of manual adjustment	+/- 2 K

The set point value was previously increased via object 25 by 1 K.

Calculation:

$$\begin{aligned}
 \text{Current set point value} &= \text{base set point} + \text{set point adjustment} \\
 &= 21^{\circ}\text{C} + 1\text{K} \\
 &= 22^{\circ}\text{C}
 \end{aligned}$$

If operation is switched to standby mode, the current set point value is calculated as follows:

$$\begin{aligned}
 \text{Current set point} &= \text{base set point} + \text{set point adjustment} - \text{reduction in standby mode} \\
 &= 21^{\circ}\text{C} + 1\text{K} - 2\text{K} \\
 &= 20^{\circ}\text{C}
 \end{aligned}$$

6.7.3.2 Calculating the setpoint value in cooling operation

Table 56: Current set point value during cooling

Operating mode	Current set point value
Comfort	Baset set point* + set point adjustment + dead zone
Standby	Base set point + set point adjustment + dead zone + increase in standby mode
Night	Base set point + set point adjustment + dead zone + increase in night mode
Frost / heat protection	configured set point value for heat protection mode

* *Base set point after reset*

Example:

Cooling in comfort mode.

The room temperature is too high and FCA 1 has switched to cooling operation

Table 57: Parameter settings:

Parameter page	Parameters	Setting
General	Supported function	Heating and cooling
Set point values	Base set point after reset	21 °C
Set point values for cooling	Dead zone between heating and cooling	2 K
	Increase in standby operation	2 K
Operating mode and operation	Limitation of manual adjustment	+/- 2 K

The set point value was previously lowered by 1 K via object 25.

Calculation:

$$\begin{aligned}
 \text{Current set point value} &= \text{base set point} + \text{set point adjustment} + \text{dead zone} \\
 &= 21^{\circ}\text{C} - 1\text{K} + 2\text{K} \\
 &= 22^{\circ}\text{C}
 \end{aligned}$$

Changing to standby mode causes a further increase in the set point value (energy saving) and gives rise to the following set point value.

$$\begin{aligned}
 \text{Set point value} &= \text{base set point} + \text{set point adjustment} + \text{dead zone} + \text{increase in standby mode} \\
 &= 21^{\circ}\text{C} - 1\text{K} + 2\text{K} + 2\text{K} \\
 &= 24^{\circ}\text{C}
 \end{aligned}$$

6.7.4 Heating and cooling in the 2 pipe system

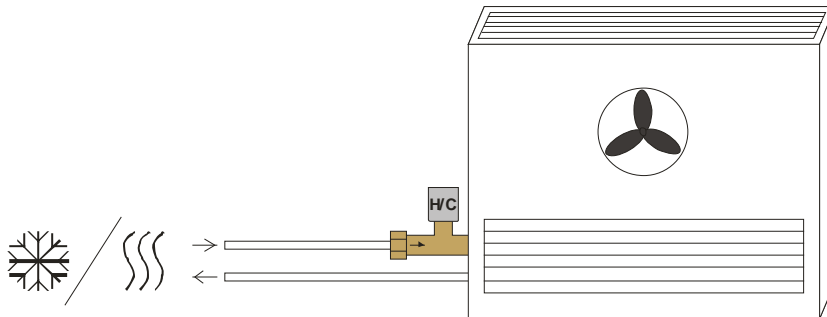

Figure 12

The following points must be observed for use in a 2 pipe heating/cooling system:

- In the 2-wire system heating and cooling mediums (depending on the season) are fed through the same channels and controlled by the same valve. This is connected to the terminals for the *VI* valve.
- The switchover between heating and cooling mediums is performed by the system and must therefore be passed on to the controller. The heating/cooling system must send a 0 for heating mode and a 1 for cooling mode to Object 1 "Switching between heating and cooling" in FCA 1.

6.7.5 Heating and cooling in the 4 pipe system

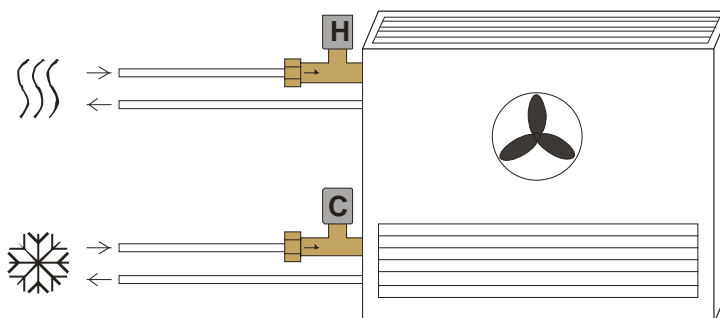

Figure 13

When used in a 4-pipe heating/cooling system the heating valve is connected to the *VI* terminals and the cooling valve to the *V2* terminals.

6.8 Fan control

6.8.1 Priorities

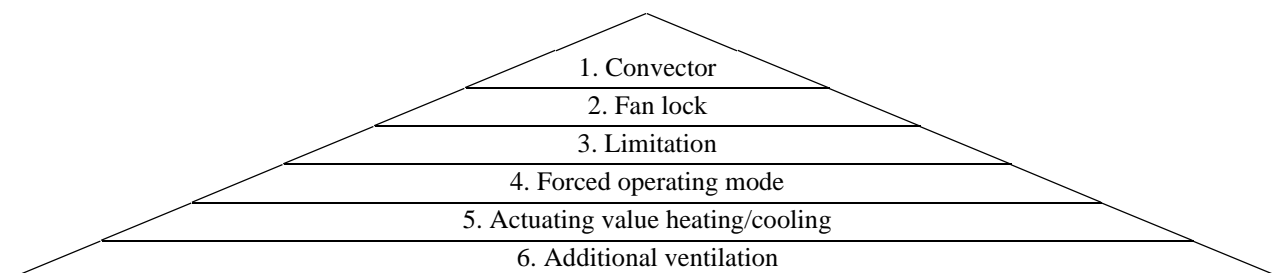

Figure 14

The *heating system = convector / fan coil* and *cooling system = convector / fan coil* parameters have the highest priority (1.). The fan is not actuated with the convector.

The *additional ventilation* parameter has the lowest priority and is only activated if the fan is to be switched off due to the actuating value and *additional ventilation* is permitted via parameters.

Important:

In the standard heating or cooling mode the *open from actuating value* parameter is taken into account (*heating valve, cooling valve* or *heating/cooling valve* parameter value).

Table 58: Example with *open from actuating value = 40 %* parameter:

Actuating value	Fan behaviour
1 .. 39 %	The fan does not start because the valve has not been opened*.
40 % .. 100%	The corresponding fan step is accepted

*The *Additional ventilation* function can still be used.

6.8.2 Time between heating and cooling and follow-up time phase

When switching between heating and cooling the heating valve is first closed; the *Follow-up time for utilisation of remaining energy* starts simultaneously (if configured). After the heating valve is closed, the configured *time between heating and cooling* operates.

The follow-up phase can continue during this time. The cooling valve can be opened at the end of the follow-up phase.

In this case, the follow-up phase will be interrupted if it has not already ended.

If the cooling valve does not have to be opened because the room temperature is in the dead zone the follow-up phase may continue.

The same procedure applies when switching between cooling and heating.

As soon as the heating valve is opened, the *warm start* phase starts if required.

Follow-up time for utilisation of remaining energy:

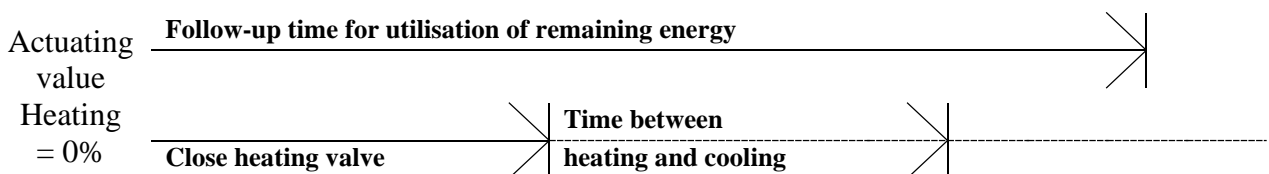

Figure 15

Transition between heating and cooling.

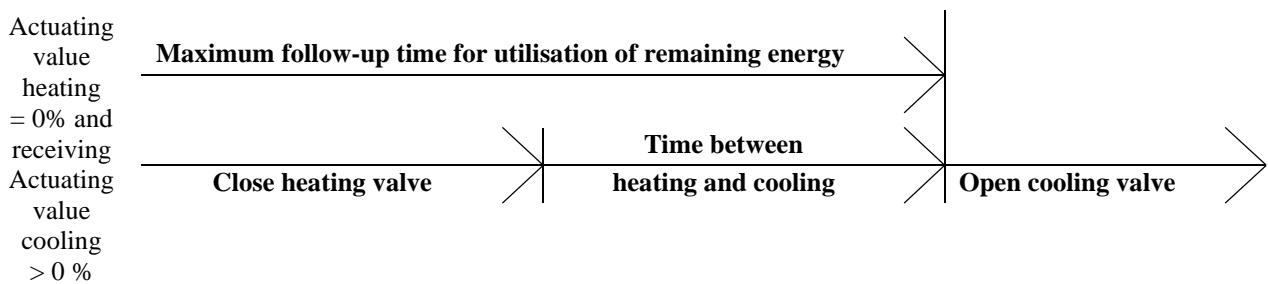

Figure 16

Transition between cooling and heating.

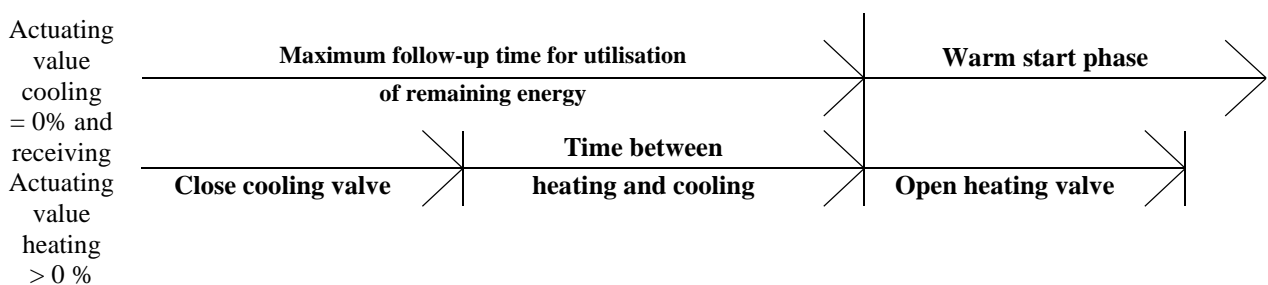

Figure 17

6.8.3 Hysteresis

To avoid unnecessary switching back and forth between fan steps they are switched with a fixed hysteresis of 10 %.

The next higher fan step is assumed when the actuating value has reached the switch-on threshold.

The next lowest fan step is only assumed if the actuating value has reduced by the value of the hysteresis (see diagram).

Example:

Switch-on threshold for fan step 1 = 10 %

Switch-on threshold for fan step 2 = 40 %

Switch-on threshold for fan step 3 = 70 %

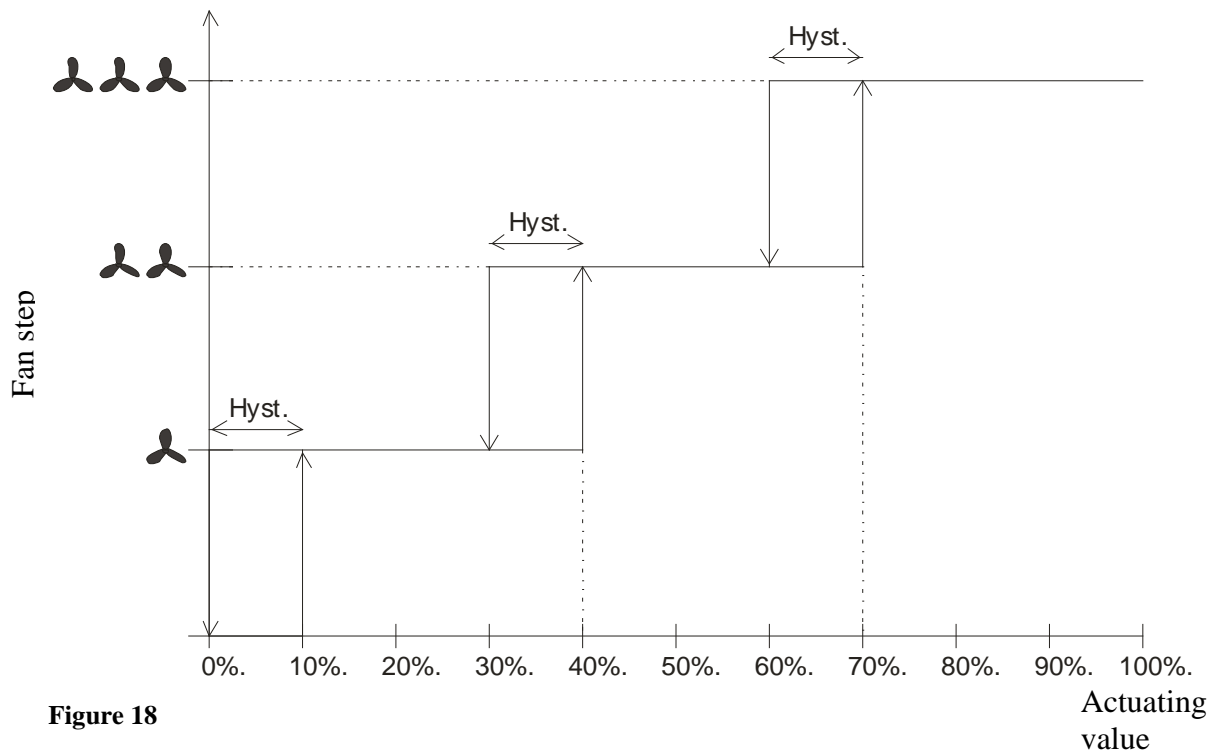

Figure 18

6.9 Temperature control

6.9.1 Introduction

The internal controller can be used as a P or a PI controller, although the PI control is preferred.

With the proportional control (P control), the control variable is statically adjusted to the control deviation.

The proportional integral control (PI control) is far more flexible, i.e. controls more quickly and more accurately.

To explain the function of both temperature controls, the following example compares the room to be heated with a vessel.

The filling level of the vessel denotes the room temperature.

The water supply denotes the radiator output.

The heat loss from the room is illustrated by a curve.

In our example, the maximum supply volume is 4 litres per minute and also denotes the maximum radiator output.

This maximum output is achieved with an actuating value of 100%.

Accordingly, with an actuating value of 50%, only half the water volume, i.e. 2 litres per minute, would flow into our vessel.

The bandwidth is 4l.

This means that the controller controls at 100% provided the actual value is smaller than, or equal, to $(211 - 41) = 171$.

Function:

- Desired filling volume:
21 litres (= set point)
- From when should the supply flow gradually be reduced in order to avoid an overflow? :
4l below the desired filling volume, i.e. at $211 - 41 = 171$ (=bandwidth)
- Original filling volume
15l (=actual value)
- The loss amounts to 1l/minute

6.9.2 Response of the P-control

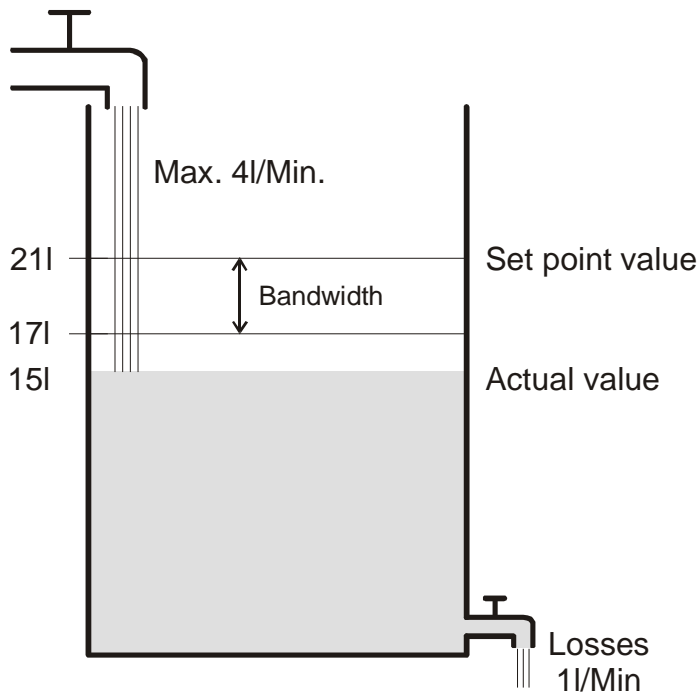

Figure 19

A filling volume of 15l gives rise to a control deviation of $211 - 151 = 61$
 Because our actual value lies outside the bandwidth, the control will control the flow at 100%
 i.e. at 4l / minute

The supply quantity (control variable) is calculated from the control deviation
 (set point value – actual value) and the bandwidth.

$$\text{Control variable} = (\text{control deviation} / \text{bandwidth}) \times 100$$

The table below shows the response and therefore also the limits of the P-control

Table 59

Filling level	Actuating value	Supply	Loss	Increase in filling level
15l	100%	4 l/min	1 l/min	3 l/min
19l	50%	2 l/min		1 l/min
20l	25%	1 l/min		0 l/min

The last line indicates that the filling level cannot increase any further, because the flow allows only the same amount of water to flow in as can flow out through loss.

The result is a permanent control deviation of 1l and the setpoint value can never be reached.

If the loss was 1l higher, the permanent control deviation would increase by the same amount and the filling level would never exceed the 19l mark.

In a room this would mean that the control deviation increases with a decreasing outside temperature.

P-control as temperature control

The P-control behaves during heating control as shown in the previous example. The set point temperature (21°C) can never quite be reached.

The permanent control deviation increases as the heat loss increases and decreases as the ambient temperature decreases.

6.9.3 Response of the PI-control

Unlike the pure P-control, the PI-control works dynamically. With this type of controller, the actuating value remains unchanged, even at a constant deviation.

In the first instant, the PI-control sends the same actuating value as the P-control, although the longer the set point value is not reached, the more this value increases.

This increase is time-controlled over the so-called integrated time.

With this calculation method, the actuating value does not change if the set point value and the actual value are the same.

Our example, therefore, shows equivalent in and outflow.

Notes on temperature control:

Effective control depends on agreement of bandwidth and integrated time with the room to be heated.

The bandwidth influences the increment of the actuating value change:

Large bandwidth = finer increment on actuating value change.

The integrated time influences the response time to temperature changes:

Long integrated time = slow response.

Poor agreement can result in either the set point value being exceeded (overshoot) or the control taking too long to reach the set point value.

The best results are generally achieved using the standard settings.