

theben

EN Time switch

SELEKTA 175 top2
1750100



307029

1. Basic safety information 4

2. Proper use 4

Disposal 4

3. Installation and connection 5

Time switch installation 5

Connecting the cable 7

Disconnecting the cable 8

4. Device description 8

Display & buttons 8

Operating instructions 9

Overview of menu selection 10

Initial start-up 11

5. Settings and functions 11

ASTRO menu 11

Change astro time/position 13

Setting the offset function 14

Set fixed switching time 15

Setting summer/winter time 16

Switch Permanent ON / OFF 17

Setting holiday function 18

Activate PIN-Code 19

Setting manual or permanent switching 20

Configure external input 21

Operating hour counter 22

Using the OBELISK top2 memory card 23



Resetting the time switch 24

6. Technische Daten 25

7. Contact 27



1. Basic safety information



WARNING

Danger of death from electric shock or fire!

- Installation should only be carried out by a qualified electrician!

- The device is designed for installation on DIN top hat rails (in accordance with EN 60715)
- Power reserve (10 years) is reduced if memory card is inserted (using battery power)
- Corresponds to type 1 BSTU nach IEC/EN 60730-2-7



OBELISK top2 memory card: Avoid mechanical overload and contamination during storage/transportation

2. Proper use

- The astronomic time switch is used, for instance, for lighting equipment (roads, external staircases, display windows, entrances etc.)
- Only for use in closed, dry rooms



Do not use on safety devices, e.g. escape route doors, fire safety equipment etc.

Disposal

- Dispose of device in environmentally sound manner

3. Installation and connection



WARNING

Danger of death from electric shock or fire!

- Installation should only be carried out by a qualified electrician!

Time switch installation

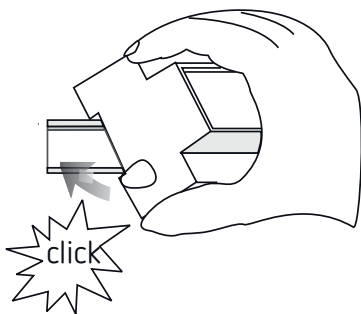

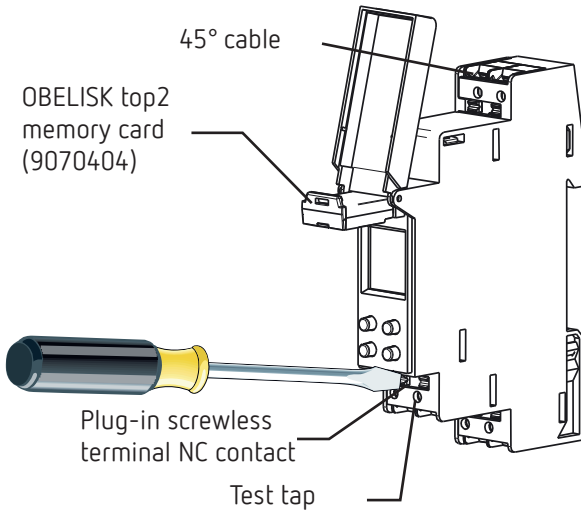

- Install on DIN top hair rails (in accordance with EN 60715)
- Disconnect power source
- Cover or shield any adjacent live components
- Ensure device cannot be switched on
- Check absence of voltage
- Earth and bypass

Connecting the cable

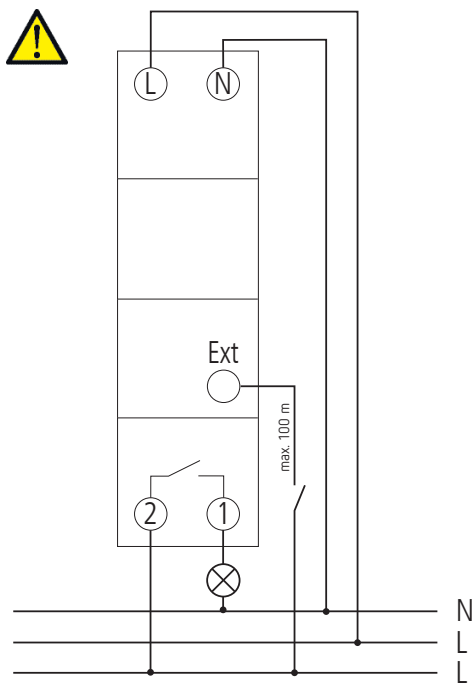

- ▶ Strip cable to 8 mm (max. 9)
- ▶ Insert cable in the open DuoFix® plug-in terminal at 45° (2 cables per terminal position possible)
- ▶ To open the DuoFix® plug-in terminal, press screwdriver downwards

Disconnecting the cable

- Use the screwdriver to push the load line connection opener downwards

4. Device description

Display & buttons

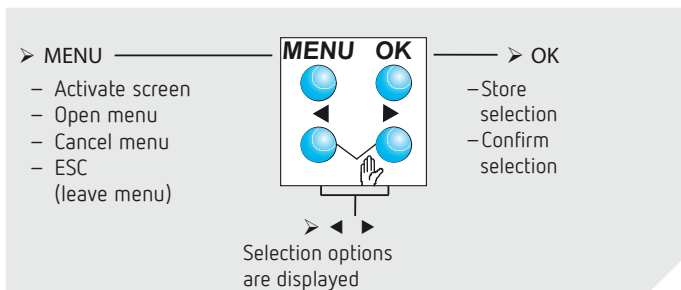
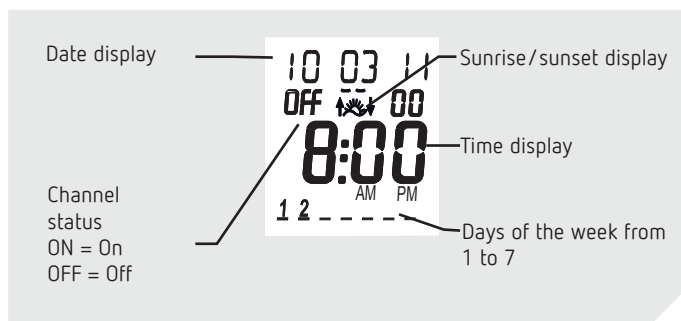

Operating instructions

1. Read text lines
Flashing text/symbol
is a prompt



2. Make a decision



YES
Confirmation

press
OK

NO
Change/
select

press
◀ ▶



Overview of menu selection

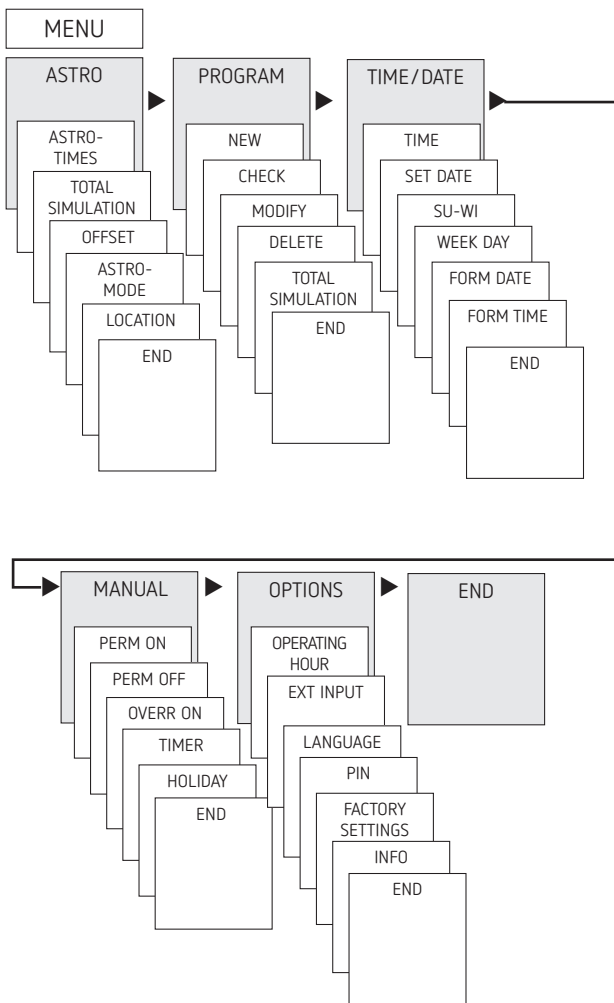

Initial start-up

- Set language, country, town/city, date, time as well as summer/winter time (SO-WI)
- Press any button and follow on-screen instructions (see figure)

5. Settings and functions

ASTRO menu

In the ASTRO menu astro times, complete simulation, offset, astromode as well as position (location) can be viewed or changed.

- Astro times
Display of the astro times (including the offsets) for the current day
- Total simulation
Display of the switching behaviour with a freely selectable Start date (the holiday program is not displayed)
- Offset
The offset (adjustment value) can be used to shift calculated astro times $+/- 120$ min. This enables the Astro switch-on and switch-off times to be adapted to local circumstances (e.g. mountains, high buildings etc.) or to personal requirements.



- Astro mode
 - Evenings on, mornings off Switches on at sunset, switches off at sunset (Example: street lighting)
 - Evenings off, mornings on Switches off at sunset, switches on at sunrise (Example: terrarium).
 - Astro inactive The astro times are ineffective (timer function only).
 - Position Location set by selecting a city or by coordinates (latitude/longitude, time zone). The OBELISK top2 memory card allows up to 10 further cities (= favourites) to be entered.



Change astro time / position

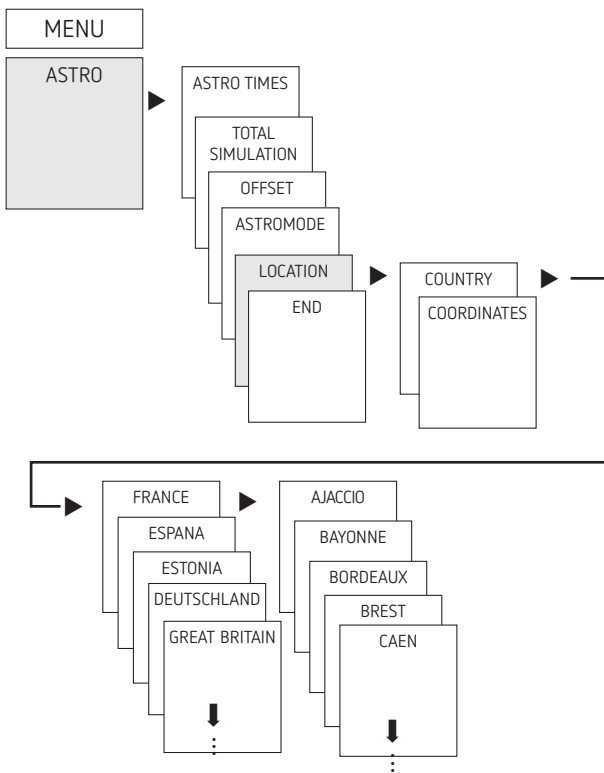

E.g. enter a different country, a different town/city
➤ Press MENU (see picture).

Setting the offset function

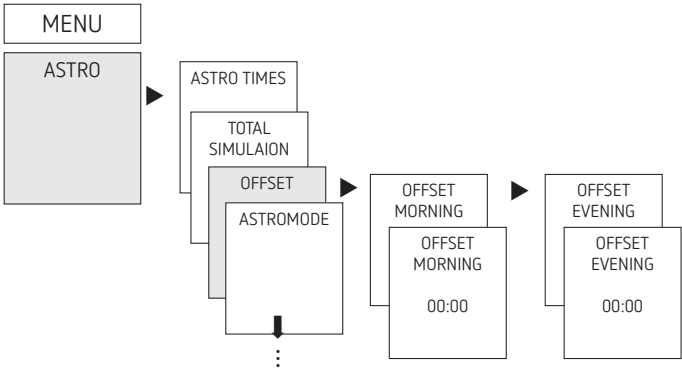

- Press MENU
- Select ASTRO and press OK to confirm
- Select OFFSET and press OK to confirm
- Select OFFSET MORNING or OFFSET EVENING and press OK to confirm
- Set the time and press OK to confirm

Set fixed switching time

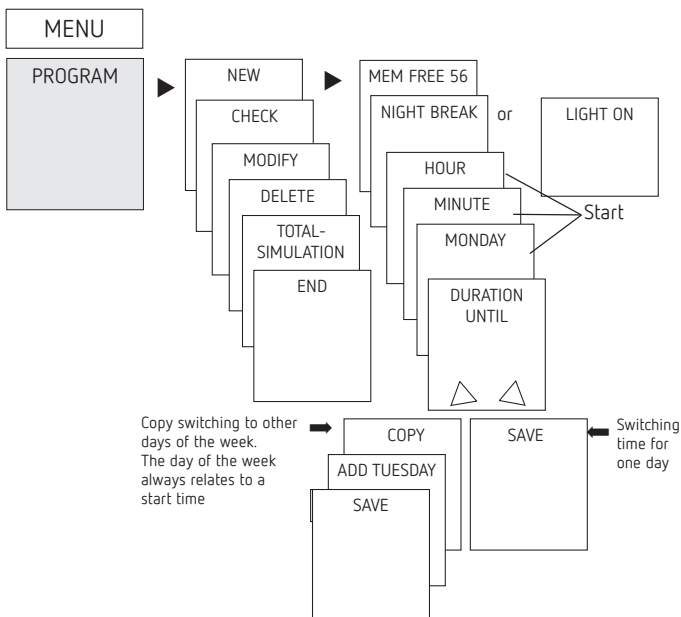

① A switching time always consists of a start time and an end time (LASTS UNTIL). e.g. night switch-off on Monday 23:00 – 05:00 hrs

① There are 56 memory cells available

- Press MENU
- Select PROGRAM and press OK to confirm
- Select NEW and press OK to confirm
- Select NIGHT SWITCH OFF or DAY SWITCH ON and press OK to confirm

- Set selected switching times (hours, minutes, day) and press OK to confirm
- Select COPY or SAVE
- To save press ► and press OK to confirm
- To copy press OK

Setting summer/winter time

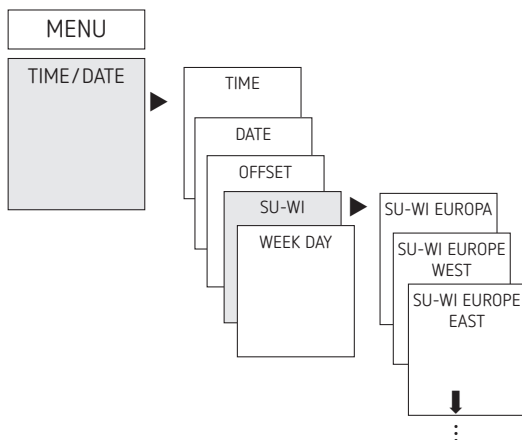

- Press MENU
- Select TIME/DAT and press OK to confirm
- Select SO-WI and press OK to confirm
- Select region for the SO-WI time and press OK to confirm

Switch Permanent ON / OFF

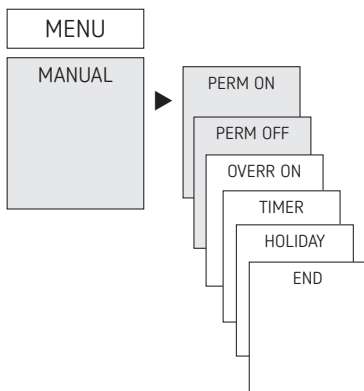

- Press MENU
- Select MANUAL and press OK to confirm
- Select PERMANENT ON or PERMANENT OFF and press OK to confirm

Setting holiday function

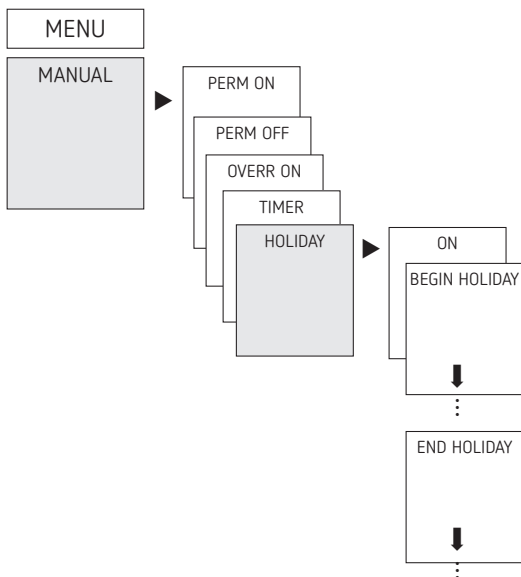

- Press MENU
- Select MANUAL and press OK to confirm
- Select HOLIDAY and press OK to confirm
- Select ON and press OK to confirm
- Select START HOLIDAY and press OK to confirm
- Enter YEAR, MONTH, DAY, HOUR and press OK to confirm
- Select END HOLIDAY and press OK to confirm
- Enter YEAR, MONTH, DAY, HOUR and press OK to confirm

Activate PIN-Code

The PIN code is set in OPTIONS via the menu.

① If you have lost the PIN, please call the Theben Hotline.

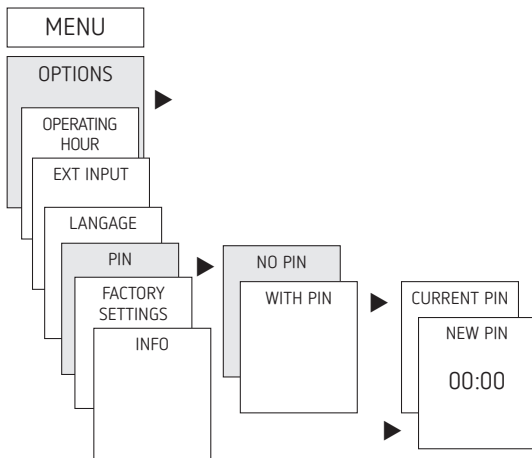

Setting manual or permanent switching

Manual and permanent switching can be set using the menu in MANUAL or (in the automatic screen) by key combination (see fig).

- Manual control
Reversing the channel status to the next automatic or programmed switching.
- Permanent switching
As long as a permanent switching (on or off) is activated, the programmed switching times are ineffective.

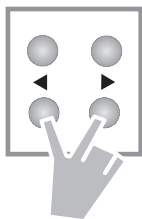

Activate manual switching

- Briefly press both keys simultaneously

Activate permanent switching

- Simultaneously press both keys for 2 seconds

Cancelling manual/permanent switching

- Press both keys simultaneously

Configure external input

For the channel, an EXTERNAL INPUT (see figure) can be set with different functions.

3 submenus are selectable: Inactive, push button (function), switch (function)

- INACTIVE: The external input has no function
- PUSH BUTTON: Manual (manual control), Timer (count-down timer) and Staircase light time switch are selectable
- SWITCH: Permanent on, permanent off and only Astro are selectable

① If a function is activated via an external push button or switch, EXTERNAL is displayed

- Press MENU, to select use ► EXT INPUT and follow the on-screen instructions



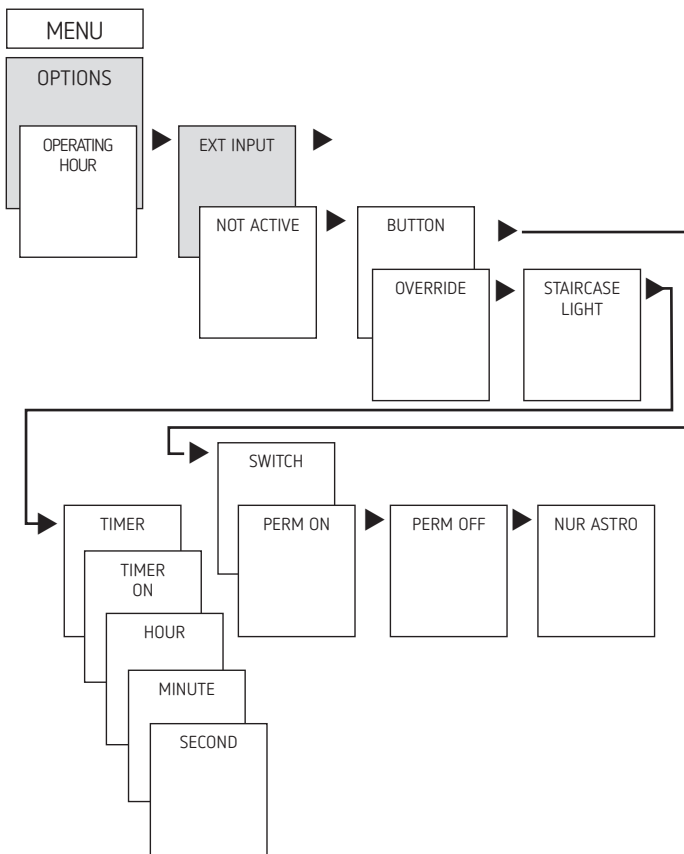

Operating hour counter

The operating hours of the channel (relay) are displayed and deleted in the OPTIONS menu. If the number of operating hours exceeds the value set in the Service menu, SERVICE will appear in the display.

Example: Replace a lamp after 5,000 h.

- Delete operating hours or set a higher value in Service (e.g. to 10,000 h)

Using the OBELISK top2 memory card

- ① The OBELISK top2 memory card is not included in the scope of supply of the device, but can be ordered as an accessory (no. 9070404).

All functions can also be set on the PC using the OBELISK software and transferred to the device via the memory card.

- Insert memory card in the time switch
- Read in/out saved switching times and device setups in the time switch or start Obelisk program
- Remove OBELISK top2 memory card after copying etc.

- ⚠ Avoid mechanical overload and contamination during storage/transport

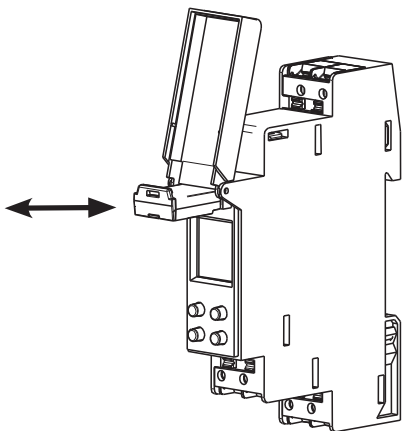

Copy OBELISK → Time switch

Copies all switching programs and settings from the time switch to the memory card. Starting OBELISK program

Copy Time switch → OBELISK

Copies all switching programs and settings from the time switch to the memory card.

Start OBELISK program

Takes on the switching times that are programmed on the memory card.

As soon as the memory card is removed, the switching times of the time switch are re-activated.



Resetting the time switch

- ▶ Press the 4 buttons simultaneously.
 - You can choose between RETAIN PROGRAM and DELETE PROGRAM.

6. Technische Daten

Operating voltage:	230–240 V AC +10 % / –15 %
Frequency	50–60 Hz
Power consumption: max	0,4 W
Standby min	0,4 W
Max switching capacity.	16 A (at 250 V AC, $\cos \varphi$ = 1)
Switching capacity	4 A (at 250 V AC, $\cos \varphi$ = 0,6)
Min. switching capacity	10 mA/230 V AC 100mA/24 V AC/DC
Gap	<3 mm
Protection rating	IP 20 in accordance with EN 60529
Protection class	II in accordance with EN 60730-1 subject to designated installation
Operating temperature	–25 °C ... +55 °C
Power reserve	10 years at +20 °C
Rated impulse voltage	4 kV
Pollution degree	2
Contact	NO contact μ
Max. switching cycles with 16 A resistive load	50 000
Incandescent lamp load	2000 W
Halogen lamp load	2000 W
Energy-saving lamp	300 W





Fluorescent lamps (LLB low-loss ballasts): uncorrected series-corrected parallel-corrected	2000 VA 2000 VA 1300 W (140 μ F)
Fluorescent lamps (EB – electro- nic ballasts)	1200 W
Mercury and sodium vapour lamps parallel-compensated	730 VA (80 μ F)
Compact fluorescent lamps (EB)	300 W
LED-lamps (<2 W)	55 W
LED-lamps (>2 W < 8 W)	180 W
LED-lamps (>8 W)	200 W
Contact material	AgSnO ₂ + tungsten prerun contact
Switch output	phase independent
Corresponds to type 1 BSTU in accordance with IEC/EN 60730- 2-7 or IEC/EN 60730-1	
SELV switching is not permitted. Switching of any external con- ductor is permitted.	

7. Contact

Theben AG
Hohenbergstr. 32
72401 Haigerloch
GERMANY
Tel. +49 7474 692-0
Fax ++49 7474 692-150

Hotline

Tel. +49 7474 692-369
hotline@theben.de

Addresses, telephone numbers etc.
www.theben.de

