

thebenHTS307174
1103087801**EN** Presence detectorthePrema S360-101 E UP WH
2070605
thePrema S360-101 E UP GR
2070606

1. Product characteristics

- Passive infrared presence detector for ceiling installation
- Square detection area 360° (up to 64 m²) for reliable and easy planning
- Automatic presence- and brightness-dependent control for lighting and HVAC
- Mixed light measurement suitable for fluorescent lamps (FL/PL/ESL), halogen/incandescent lamps and LEDs
- Channel A light: relay, 230 V
- Fully or semi-automatic operation, switchable
- Brightness switching value configurable, teach-in function
- Self-learning time delay
- Reduction of time delay when present briefly (short-term presence)
- Connection option for push buttons or switches for manual switching with automatic detection of «push button/switch»
- Pulse function for staircase light timer switch
- Channel H, presence: relay, floating e.g. for HVAC control
- Switch-on delay and time delay configurable
- Room monitoring with selective movement detection
- Ready for immediate use due to factory presetting
- Exceptionally easy configuration of the energy-saving response with the new «eco plus» function
- Test mode for checking function and detection area
- Extension of detection area via master/slave or master/master switching, a maximum of 10 detectors can be switched in parallel with each other
- Flexible relay operating modes
- Ceiling installation in flush-mounted box
- Surface mounting on ceilings possible with back box (option)
- User remote control «theSenda S» (option)
- Management remote control «SendoPro» (option)
- Installation remote control «theSenda P» (option)

2. Safety

**WARNING****Danger of death through electric shock or fire!**

➤ Installation should only be carried out by a qualified electrician!

- Work on electrical systems may only be carried out by qualified electricians or by instructed persons under the guidance and supervision of a qualified electrician in accordance with the technical regulations applying to electricity!
- Comply with the country-specific safety regulations for work on electrical systems! Ensure absence of voltage in the cable before installation!
- The device is maintenance-free. If the device is opened or penetrated with any object, the guarantee lapses.

3. Proper use

The presence detector is intended for interior installation. The presence detector is exclusively intended for the use as contractually agreed between the manufacturer and the user. Any other use is considered to be unacceptable. The manufacturer does not accept liability for any resulting damages.

4. Operation

The presence detector is primarily used in offices and schools, as well as in homes, for easy and energy-efficient control of lighting plus HVAC and shading. The switch contact "light" switches lighting on with presence and insufficient brightness, and off with absence or sufficient brightness. The light can also be switched on/off manually using buttons or switches.

The "Presence" switch contact controls heating, ventilation and air conditioning systems. The contact closes when someone is present, a switch-on delay permits delayed switch on. The contact can also be used for room monitoring. It then responds with reduced sensitivity only to distinct movements.

Function description

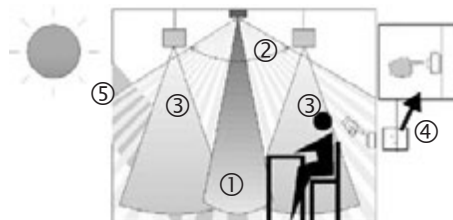

- ① Mixed light measurement
- ② Presence detection
- ③ Artificial light
- ④ Push button for manual lighting control
- ⑤ Incident daylight

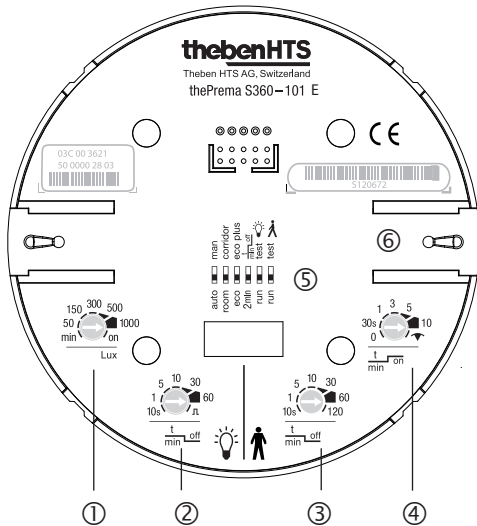

Settings on thePrema S360-101

- ① Brightness setpoint value (lux)
- ② Lighting time delay
- ③ Presence time delay
- ④ Presence switch-on delay
- ⑤ DIP-Switch:
 - DIP1 Fully automatic/semi-automatic
 - DIP2 Staircase light function:
room/corridor
 - DIP3 eco/eco plus
 - DIP4 Short-term presence On/Off
 - DIP5 Light test: normal operation/test
 - DIP6 Presence test: normal operation/
Walking test
- ⑥ Mechanical safety lock

Light channel A

Switching response is controlled by presence and brightness. The switch contact closes during darkness **and** when someone is present. It opens with a delay when there is brightness **or** when no one is present.

Time delay

The minimum time delay (10 s - 60 min) is adjustable. It adjusts automatically to the user's behaviour and can increase independently to max. 30 minutes or reduce back to the set minimum time. With settings ≤ 2 min or ≥ 30 min, the time delay remains unchanged at the set value. If someone goes into an unoccupied room only briefly and leaves it within 30 seconds, then the light will be switched off prematurely after 2 minutes (short-term presence).

Button control

The lighting can be manually switched at any time via a push button or switch. If the light is switched on manually, it will remain on for at least 30 minutes provided that people are present. It then switches off when the brightness is adequate. The light is forced off after the preset time delay if the room was (previously) vacated. If artificial lighting is switched off manually, the lighting remains switched off as long as the room is occupied. The lighting switches again automatically after the time delay has expired.

Fully or semi-automatic device

Lighting control via the presence detector operates fully automatically for increased comfort or semi-automatically for greater energy savings. The lighting switches on and off automatically in "fully automatic" mode. In "semi-automatic", the lighting must always be switched on manually. The lighting is switched off automatically.

Staircase light function

The staircase light function can be set to "room" or "corridor" using the DIP switch or the SendoPro management remote control. Lighting can be switched on and off manually at any time in the 'room' position. The detector operates as a staircase light control in the 'corridor' setting. Manual switch off is no longer possible.

Exceptionally easy configuration of the energy-saving behaviour

By selecting "eco" for optimal switching behaviour or "eco plus" for maximum energy saving, users can adjust the presence detector to their requirements very easily.

Pulse function

Time delay can be set to pulse for controlling existing staircase light timer switch. To do so, the light output produces a pulse of 0.5 seconds duration every 10 seconds if people are present or it is dark.

Relay operating mode

The light relay can be deactivated. Further information can be found on page 8, relay operating mode.

Presence channel H

Presence channel H is used for HVAC control or room monitoring. The switching response of the floating contact is influenced only by presence and not by brightness. If the contact is closed, the time delay will be restarted at every movement. Sensors or switches do not influence the contact.

Switch-on delay

The switch-on delay prevents instantaneous switching on. The contact closes only on expiry of the switch-on delay, provided that people are permanently present.

Time delay

The time delay enables delayed switching off of HVAC devices and systems after the room is vacated.

Room monitoring

If the switch-on delay is set to monitoring, this reduces the sensitivity of the presence switch output. The contact closes on distinct movement and indicates the presence of people with a high degree of certainty. The time delay remains active. The switch-on delay is inactive.

Relay operating mode

The presence relay can be used with different operating modes. Presence channel H and light channel A can be selected, while the light relay can be deactivated if desired. This makes switching more quiet. Further information can be found on page 8, relay operating mode.

5. Detection area

The square detection area of the presence detector guarantees accurate and simple planning. Square detection areas make it possible to cover a whole room with parallel switching. Note that seated and walking persons are detected in differently-sized areas. The recommended installation height is 2.0 m – 3.0 m. The sensitivity of the presence detector decreases with higher installation heights. At an installation height of 3 m or higher, walking motions are necessary and the detection areas of several detectors should overlap in the marginal zones. The detection range is reduced as temperatures increase.

Seated persons:

The presence detector reacts very sensitively to the slightest movements. The details refer to smallest movements at table height (approx. 0.80 m). The detection sensitivity is reduced from an installation height of > 3 m. More pronounced movements are required for clear detection.

Walking persons:

Use of the whole detection area.

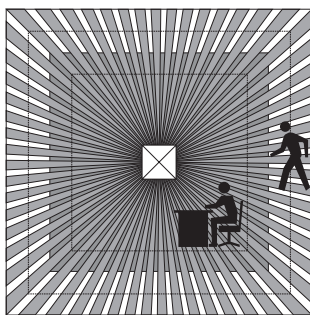
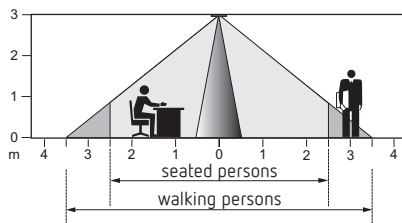

Installation height	seated persons		walking persons	
2.0 m	9 m ²	3.0 m x 3.0 m	20 m ²	4.5 m x 4.5 m ± 0.5 m
2.5 m	16 m ²	4.0 m x 4.0 m	36 m ²	6.0 m x 6.0 m ± 0.5 m
3.0 m	25 m ²	5.0 m x 5.0 m	49 m ²	7.0 m x 7.0 m ± 1.0 m
3.5 m	---		64 m ²	8.0 m x 8.0 m ± 1.0 m

Brightness measurement

The presence detector measures artificial light and daylight (opening angle for each approx. ± 30°). The installation location is the reference point for the lighting level. The brightness measurement can be adapted to the conditions in a room with the room correction factor. The light measurement area maps a rectangle of about 2 x 3.5 m at table height. Direct light influences the light measurement. Avoid placing floor lamps or suspended lighting directly below the detector. If the brightness measurement is deactivated, light channel A only switches depending on presence (brightness switching value set to "on" via potentiometer or set to "measurement off" via the remote control).

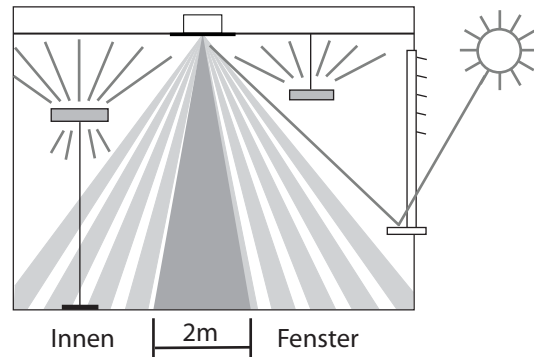

Suitable lamps

The presence detector is designed for the operation of fluorescent lamps, compact fluorescent lamps, halogen/incandescent lamps and LEDs. The maximum number of switchable lights is restricted due to the high inrush current levels of the EBs and LED drivers. The use of an external contactor helps with large loads. Parallel switching enables allocation of load to several Masters. All switched loads must be properly interference suppressed.

6. Installation

Flush-mounted fitting

The presence detector is flush-mounted using a size 1 standard flush-mounting installation socket.

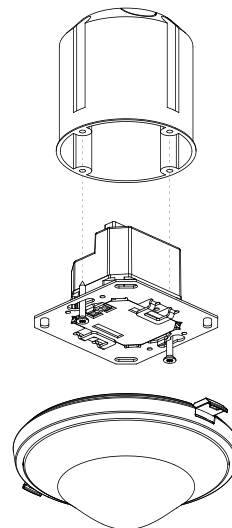

Ceiling installation

A ceiling installation box 73 A is available for a simplified ceiling installation of the presence detector (see accessories). This also ensures cord grip and contact protection. The installation diameter is 72 mm (drill diameter 73 mm).

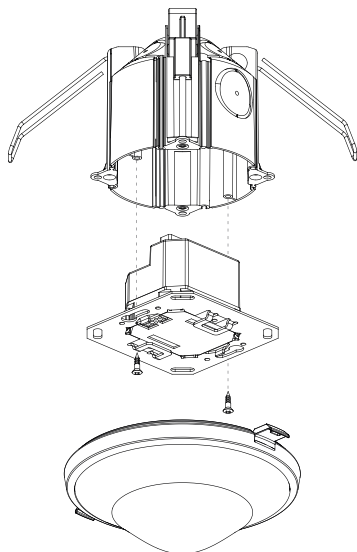

Surface-mounted installation

A back box 110A, protection rating IP 40, is available for surface mounted installation (see accessories).

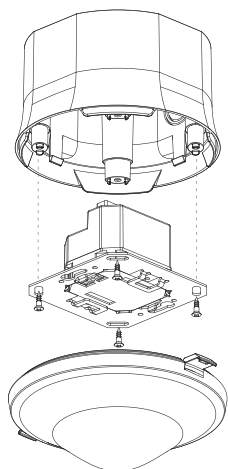

7. Connection

The presence detectors can be combined as master and slave: master in individual switching, master in parallel switching, master-slave parallel switching.

Several push buttons can be connected to one control input. Illuminated push buttons can only be used with neutral conductor connection.

Individual switching

In individual switching, the presence detector as master detects presence and brightness and controls lighting.

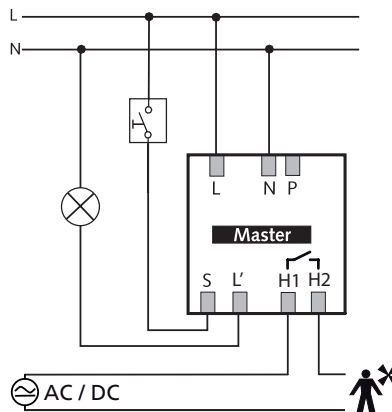

Master/slave parallel switching

If the detection area covered by one presence detector is insufficient (larger rooms), then up to 10 detectors can be operated in parallel by connecting P terminals. In the process, presence detection is performed by all detectors together. The master measures the brightness, operates the push buttons and controls the lighting. All other detectors are used as slaves. They only provide presence information.

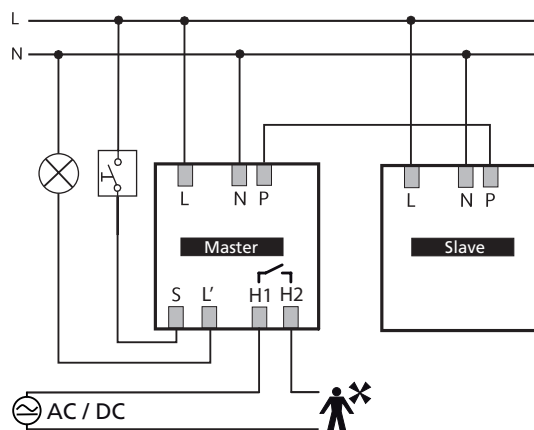

- Light measurement only with the master
- Parameters are only set on the master
- Switch up to 10 detectors in parallel
- Use the phase with the same phase for all detectors.

Master: thePrema S360 -101

Slave: thePrema P360 Slave, thePrema S360 Slave

Master/master parallel switching (for several lighting groups)

Several masters can be used in parallel switching setup. Each master controls its lighting group according to its own brightness measurements. Delay times and brightness switching values are set individually on each master. Presence continues to be detected by all the detectors.

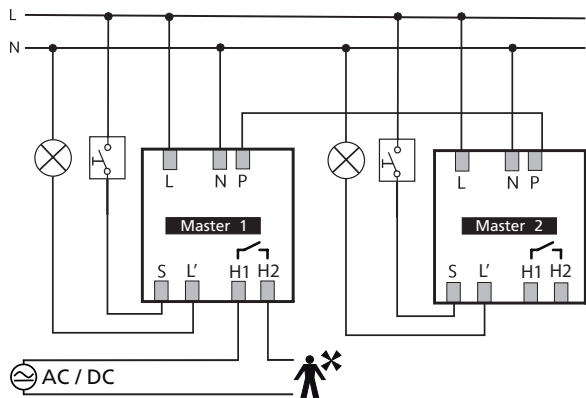

- One master with individual brightness measurement per lighting group
- Set potentiometer and DIP switch individually for each master
- Switch up to 10 detectors in parallel.
- Use the phase with the same phase for all detectors.
- The presence switch contact can be read by any master.

Parallel switching on external staircase light timer switch

One or several presence detectors control a staircase light timer switch as master. Their time delay is set to short pulse. When people are present and there is insufficient brightness, their switch contacts close every 10 seconds for a period of 0.5 seconds and thus restart the time delay of the staircase light timer switch.

- Switch light switch contacts of several detectors directly in parallel.
- Set light time delay in all detectors to short pulse.
- Use the phase conductor with the same phase for all detectors.
- Staircase light timer switch, e.g. Theben ELPA 1

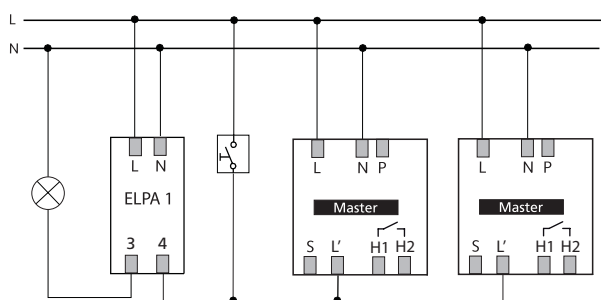

Presence detectors as a staircase light timer switch

As master, a presence detector assumes the function of the staircase light timer switch. At the master, the DIP switch is set to "corridor". With every detected movement or push button activation, the time delay is restarted. However, the lighting cannot be switched off with the push button. If the detection area covered by one presence detector is

insufficient (larger rooms), then up to 10 presence detectors can be operated in parallel as slaves by connecting P terminals.

- Master switches lighting directly.
- Push button starts the time delay of the master.
- DIP switch to "corridor" prevents switching off with the push button.
- If needed, switch additional slaves in parallel via P terminals.
- Use the phase with the same phase for all detectors.
- Potentiometers and DIP switches are only set on the master.

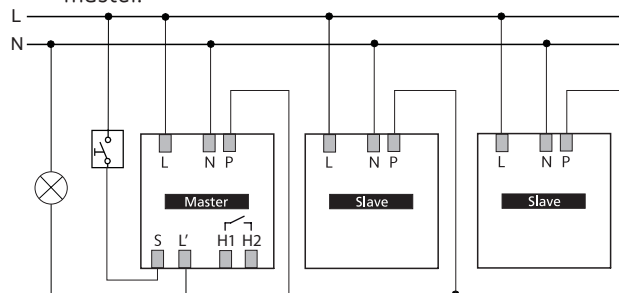

Master: thePrema S360 -101

Slave: thePrema S360 Slave

8. Settings

The presence detectors were supplied with basic settings ready for operation. The specifications are guidance values. Management remote controls are optionally available for start-up. They enable remote setting of all potentiometer values and DIP switch settings from a distance.

Settings of switch contact light channel A

Potentiometer brightness switching value "lux"

The required brightness switching value can be set via the lux potentiometer.

The setting range is around 10 to 1000 lux. The factory pre-setting is 300 lux.

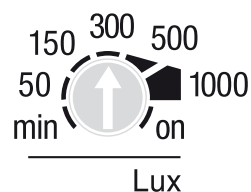

Brightness switching values from 5 to 3000 lux can be set via the management remote control.

According to standard EN 12464, the following settings are recommended:

Transit zones (no work area)	150 lux
Classroom	300 lux
Work areas (office, meeting room)	500 lux
Visually-intensive work (laboratory, drawing, etc.)	750 lux

Brightness measurement can be deactivated. In this case, the brightness has no influence, and channel A light always switches at presence/absence.

Deactivation of the brightness measurement: set the potentiometer to „on“.

The lux scale applies for rooms with average room design. It is recommended that the room correction factor be adjusted with the management remote control according to the installation location, light incidence, reflection characteristics of the room and the furniture.

Potentiometer lighting time delay

The following guidance values have proved themselves in practice and are recommended as settings:

- Transit zones (no work area) approx. 5 min
- Classroom approx. 10 min
- Work areas (office, living room) approx. 10 min
- When settings are between 2 - 30 mins the time delay varies within this range in a self-learning way. Setting values ≤ 2 min or ≥ 30 min remain fixed. Only active with the setting "eco".
- \perp "Pulse": Control staircase light timer switch (0.5 s "on" / 10 s "off")

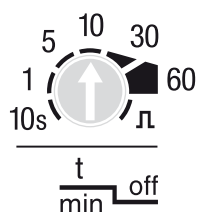

DIP switch fully/semi-automatic (auto/man)

auto man

Description of the function semi-automatic or fully automatic, see function description:

- "auto": fully automatic: the lighting switches on and off automatically.
- "man": semi-automatic: switching on always has to be completed manually. Switching off occurs automatically.

DIP switch staircase light function (room/corridor)

room corridor

For description of the staircase light function, see function description:

- "room" : manual switching on and off possible
- "corridor": detector is used as staircase light timer switch. Manual switch off is no longer possible

DIP switch energy saving behaviour (eco/eco plus)

eco eco plus

Selection of "eco" for optimal switching behaviour or "eco plus" for maximum energy saving.

- "eco": The time delay adapts to the user behaviour in a self-learning way. It does not drop below the set value.
- "eco plus" : The set time delay remains unchanged (no self-learning effect). Faster response to brightness detection than with „eco“.

DIP switch short-term presence (On/Off)

2min $\frac{t}{\text{min}}$ off

For description of short-term presence, see function description:

- „2 min“ short-term presence is switched on
- „ $\frac{t}{\text{min}}$ off“ Short-term presence is switched off.

Settings of switch contact presence

Potentiometer presence time delay

The contact closes if people are present and opens when the room is vacated after the time delay expires. The set values remain unchanged (no self-learning effect).

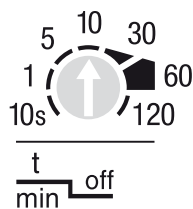

Potentiometer presence switch-on delay

- The contact only closes when someone is present after expiry of the switch-on delay
- 0 = contact closes immediately if people are present
-  "Room monitoring": contact closes only when a significant movement occurs (high false alarm safety). The switch-on delay is deactivated.

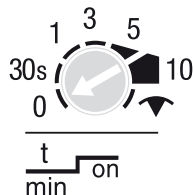

Parameters and control commands via remote control

The following parameters can be queried or changed via the remote control for support during installation as well as servicing:

Parameters	Description	Can be queried SendoPro 868-A	Can be changed SendoPro 868-A	Can be changed theSenda P
Brightness switching value A	Value range in lux	x	x	x
	Measurement off	x	x	x
Room correction factor A	Room correction factor		x	
Brightness actual value A	Query brightness actual value	x		
Time delay A	Value ranges in seconds / minutes		x	x
	Pulse		x	x
Short presence A	Short-term presence: On/Off		x	
Time delay H	Value ranges in seconds / minutes		x	x
Switch-on delay H	Value ranges in seconds / minutes		x	
Assignment channel A	Assignment function relay H: L' / L' + H / H		x	
Energy saving mode	Selection: eco / eco plus	x	x	
Configuration type	Selection: auto / man	x	x	x
Staircase light function	Selection: Off / On		x	
Control input S	Auto / switch / push button S / push button O		x	
Detection sensitivity	Detection Sensitivity (PIR): value range in Increments		x	x
Monitoring sensitivity reduction	Room monitoring sensitivity: value range in Increments		x	
Group address	Selection: I / II / III / all		x	
Scene 1	Off / On		x	
Scene 2	Off / On		x	
LED display motion	Off / On		x	

The parameters are sent to the presence detector with the "SendoPro 868-A" management remote control or with "theSenda P" installation remote control via infra-red. Changed parameters are immediately applied and used by the detector.

With the "SendoPro 868-A" management remote control, parameters can be queried by sending values level-by-level to the detector. If the sent value is below the set parameter, the LED illuminates briefly. If the sent value is equal or above the set parameter, the LED flickers for 2 seconds.

The following control commands can be triggered with the remote control:

Control command	Description	Can be triggered SendoPro 868-A	Can be triggered theSenda P
Teach-in channel A	Activation	x	x
Switching light	Lighting group can be switched on and off.	x	x
Presence test	Off / On	x	x
Light test	Off / On	x	

Control command	Description	Can be triggered SendoPro 868-A	Can be triggered theSenda P
Restart	Restart detector	x	x
Local settings	Detector applies the settings of the DIP switch and all potentiometers	x	
Factory settings	Set all parameters and settings to factory setting.	x	

Brightness switching value A

The brightness switching value defines the minimum desired brightness. The currently prevailing brightness is measured below the presence detector. If the prevailing brightness is below the switching value, the light switches on when a presence is detected (in configuration type fully automatic device).

Value range

<p>Lux values with "SendoPro 868-A" management remote control In the installation remote control "theSenda P", the following values are available</p> <p>(The currently measured brightness value (Lux) can be adopted with the "SendoPro 868-A" management remote control, with the teach-in control command or with the "theSenda P" installation remote control via the teach-in button.) Values outside the permitted range will automatically be set to the appropriate limit value.</p>	<p>5 – 3000 lux 5, 10, 15, 300, 500, 800 lux</p>
<p>- Deactivating the brightness measurement (the brightness has no influence) - The light channels only switch according to presence/absence. Possible with "SendoPro 868-A" management remote control or "theSenda P" installation remote control.</p>	<p>Measurement off Button ☀</p>

Room correction factor A

The room correction factor is a measurement for the difference of the brightness measurement on the ceiling and the work area. The brightness measurement value at the ceiling is influenced by the installation location, incidence of light, position of the sun, weather conditions, the reflection properties of the room, and the furniture. With the room correction factor, the brightness measurement value of lighting channel A is adjusted to the conditions in the room and in this way can be matched to the lux meter value ① measured at the surface beneath the presence detector.

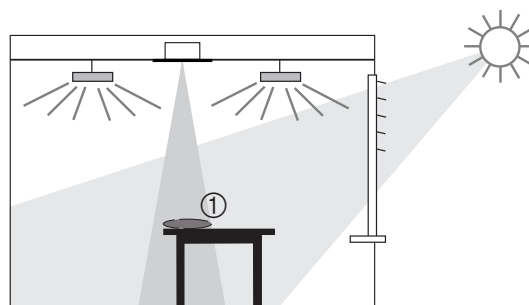

Room correction factor = Brightness value at the ceiling / brightness value at the working surface

We recommend the following procedure:

- Place the lux meter on the work surface below the sensor and note down the measured lux value.
- Query „brightness actual value A” with the «SendoPro 868-A» management remote control.
- Calculating the room correction factor: „brightness actual value A” / lux value of lux meter.
- Enter „room correction factor A” with the «SendoPro 868-A» management remote control. Values between 0.05 and 2.0 are permitted. Entered values outside the permitted range will automatically be set to the appropriate limit value. The entered room correction factor will be applied immediately.

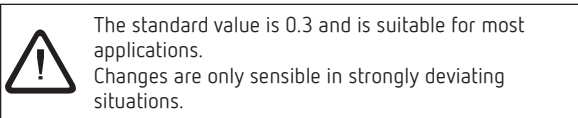

Time delay A

Value range

Adjustable values with "SendoPro 868-A" management remote control In the "theSenda P" installation remote control, the following values are available	10 s - 60 min 10 s, 30 s, 60 s, 2 min, 10 min, 20 min, 60 min
Control for staircase light timer switch (0.5 s "on" / 10 s "off") "SendoPro 868-A" "theSenda P"	Pulse Button 1

Short-term presence

The time delay of Channel A light can be switched off sooner if a room is occupied only for a short time. (In fully automatic device and semi-automatic device configuration type)

The time delay is applied according to the set time delay.	off
If someone enters an unoccupied room and it is only occupied for up to 30 seconds, the light will be switched off prematurely after 2 minutes.	On

Time delay H

The presence channel always switches, regardless of whether configuration type is set to fully automatic device or semi-automatic. The set values remain unchanged. The relay contact opens once the room is vacated after the set time delay expires.

Value range

Adjustable values "SendoPro 868-A"	10 s ... 120 min
Adjustable values "theSenda P"	10 s, 30 s, 60 s, 2 min, 10 min, 20 min, 120 min

Switch-on delay H

The presence channel always switches, regardless of whether configuration type is set to fully automatic device or semi-automatic. The relay contact only closes when someone is present after expiry of the set switch-on delay.

Value range

Adjustable values	0 s, 30 s, 1 ...10 min
No switch-on delay (relay contact closes immediately when someone is present)	0 s

Adjustment possible only with "SendoPro 868-A".

Assignment channel A (relay operating mode)

With the parameter „Assignment channel A” the operating mode and behaviour of the light and presence relay can be defined.

Assignment channel A	Light relay	Presence relay	Functionality
L'	Light channel A	Presence channel H	Light and presence separately
L' + H	Light channel A	Light channel A	Presence relay switches as lighting channel
N	no function	Light channel A	Light relay deactivated, presence relay switches as lighting channel

The parameter „Assignment channel A” can only be set with the «SendoPro 868-A» management remote control. Factory setting of „Assignment channel A” is L'.

- Observe the performance specifications of the presence relay.

Energy saving mode eco/eco plus

With the «SendoPro 868-A» management remote control, the energy-saving behaviour can be set very simply. The selection of "eco" stands for optimum switching behaviour, while "eco plus" stands for maximum energy saving.

- "eco": The time delay adapts to the user behaviour in a self-learning way. It does not drop below the set value.
- "eco plus": The set time delay remains unchanged (no self-learning effect). Faster response to brightness detection than with "eco".

Configuration type

Fully automatic device: The lighting switches on and off automatically. (due to presence/no presence and brightness)	auto
Semi-automatic: Switch on must always occur manually. Switch off occurs automatically by the presence detector. (due to presence or brightness)	man

Control input S

Control input S for manual switch on/off of Channel A light automatically detects push buttons or switches. Several push buttons can be connected to control input S. Use light push button only with neutral conductor connector

Value range

Automatic detection of push button or switch. A signal that is present for less than 0.7 s is detected as a push button. Longer signals are evaluated as a switch.	auto
--	------

To adapt to user behaviour, the type of signal transmitter used can be set to fixed. Automatic detection is deactivated. When selecting the push button, opening contact or NO contact can also be specified.	Switch	Switch
	Push button (NO contact)	Push button S
	Push button (opening contact)	Push button O

Adjustment possible only with "SendoPro 868-A".

Detection sensitivity

The detector has 5 sensitivity increments. The basic setting is the middle increment (3).

By selecting the test presence operating mode, the set sensitivity increment is not changed.

Increments 1 to 5 can be selected and sent to the detector with the «SendoPro 868-A» management remote control. On the «theSenda P» installation remote control, the sensitivity can be increased or decreased by one increment each time the button is pushed.

	Sensitivity
1	very insensitive
2	insensitive
3	Standard
4	sensitive
5	very sensitive

Room monitoring sensitivity

The detector has 3 sensitivity levels. The basic setting is the middle increment 2.

Sensitivity increments 1 to 3 can be selected and sent to the detector with the «SendoPro 868-A» management remote control.

	Sensitivity
1	insensitive
2	Standard
3	sensitive

Description of room monitoring function, see section „Presence  channel“.

Group address channel A

This parameter is applied when using the "theSenda S" user remote control.

A group address can be assigned to Channel A light. The "SendoPro 868-A" or "theSenda S" can be used to program the group addresses in the detector.

Group address value range

Adjustable values "SendoPro 868-A"	I, II , III , All
Adjustable values "theSenda S"	I, II

LED display motion

The motion detection can be displayed via the LED.

Value range

No display of motion detection.	off
The LED is switched on when motion is detected, otherwise switched off.	On

Adjustment possible only with "SendoPro 868-A".

Teach-in channel A

With teach-in, the currently measured brightness value is accepted as brightness switching value A. Values outside the permitted range will automatically be set to the appropriate limit value.

The control command teach-in can be adopted with the "SendoPro 868-A" management remote control or with the "theSenda P" installation remote control via the  button.

Factory settings

The presence detector thePrema P360-101 is supplied with the following parameter values:

Parameters	Value
Brightness switching value A	300 Lux
Room correction factor A	0.3
Time delay A	10 min
Short presence A	On
Time delay H	10 min
Switch-on delay H	0 s
Assignment channel A	L'
Energy saving mode	eco
Configuration type	auto
Staircase light function	off
Control input S	auto
Detection sensitivity	Increment 3
Monitoring sensitivity reduction	Increment 2
Group address	I
Scene 1	On
Scene 2	off
LED display motion	off

9. Start-up

Switch-on behaviour

Every time the sensor unit is inserted into the power supply unit, or every time the power supply is switched on, the presence detector runs through two phases that are shown by an LED:

1. Start-up phase (30 s)

- The red LED flashes at one second intervals, both switch contacts are closed (light and presence on).
- The detector does not react to push button commands and remote control commands.
- When no one is present, both contacts open after 30 seconds.

2. Operation



The detector is ready for operation (LED off).

Presence test

Presence test mode is used to test presence detection and wiring. The presence test mode can be activated directly on the presence detector via DIP switch, with the "SendoPro 868 A" management remote control, or "theSenda P" installation remote control.

Setting presence test mode with DIP switch

- Set DIP switch to "Test " (in parallel switching with all detectors).

run  test 

1. Start-up phase (30 s)

The contact is closed for 30 seconds. Every movement is indicated by the LED.

2. Operation

- Every movement is indicated by the LED.
- When movement occurs, the light and presence switch contacts close.
- When no one is present, the light switch contact opens after 10 seconds.
- Brightness measurement deactivated, detector does not react to brightness.
- The detector reacts as in configuration type fully automatic device, even if semi-automatic is set.
- Detector stays permanently in the test phase.

Setting the presence test mode via remote control

- The detector goes directly into test mode when the test mode is set via the remote control:
- Every movement is indicated by the LED.
- When movement occurs, the light and presence switch contacts close.
- When no one is present, the light switch contact opens after 10 seconds.
- Brightness measurement deactivated, detector does not react to brightness.
- The detector reacts as in configuration type fully automatic device, even if semi-automatic is set.
- Teach-in cannot be activated in test mode.
- Test mode ends automatically after 10 min. The detector performs a new start (see switch-on behaviour).

Light test

The light test mode is used to check the brightness threshold and the adaptive behaviour.

Setting the light test mode via DIP switch

Set the DIP switch at the master to "Test ".

run  test 

1. Start-up phase (30 s)

The contact is closed for 30 seconds. The LED shows the light test mode (3 seconds on, 0.3 seconds off).





2. Operation

- The LED shows the light test mode (3 seconds on, 0.3 seconds off).
- The presence detector responds as in normal operating mode, only the reaction to bright/dark is faster.
- In order to simulate this behaviour, either the area below the presence detector can be illuminated or the blinds operated.
- **Note:** Do **not** use a torch to switch the presence detector! The adaptive light switching thresholds will be distorted!
- Detector stays permanently in the test phase.

Setting the light test mode via remote control

- The detector goes directly into test mode without the start-up phase when setting the test mode with the remote control.
- Test mode ends automatically after 10 min. The detector performs a new start (see switch-on behaviour).

10. Technical Data

Operating voltage	110–230 V AC, +10 % / –15 %
Frequency	50–60 Hz
Upstream protection device:	16 A
Power consumption	approx. 0.1 W
Type of installation	Ceiling installation; Flush / surface mounted or ceiling installation
Installation height	2.0 – 3.5 m
Minimum height	> 1.7 m
Detection area	horizontal 360° vertical 120°
Maximum range	5 x 5 m (Mh. 3.5 m) / 25 m ² seated 8 x 8 m (Mh. 3.5 m) / 64 m ² moving
Setting range brightness switching value	approx. 5 – 3000 lux
Lighting time delay	10 s – 60 min/pulse
Presence time delay	10 s – 120 min
Switch-on delay "presence"	0 s – 10 min / Room monitoring
Channel A light	Relay 230 V / 10 A, μ -contact
Max. switching capacity $\cos \varphi$ 1 ohmic	2300 W 
Max. switching capacity $\cos \varphi$ 0.5 Power factor 0.5	1150 VA   
LED lamps	
< 2 W	60 W
2 – 8 W	180 W
> 8 W	200 W
Guidance value max. inrush current level	800 A / 200 μ s
Maximum number EBs T5/T8	16 x 54/58 W, 24 x 35/36 W 8 x 2 x 54/58 W 12 x 2 x 35/36 W
Channel H, presence	Relay, floating, base insulation
Maximum voltage	220 V DC / 250 V AC
Maximum switching capacity	50 W / 50 VA (max. 2 A)
Recommended minimum load	10 mV / 10 mA

Connection type	Screw terminals
Max. cable cross-section	max. 2 x 2.5 mm ²
Size of flush-mounted box	Size 1, Ø 55 mm (NIS, PMI)
Protection rating	IP 20 (IP 40 installed)
Ambient temperature	0 °C – 50 °C
CE Declaration of Conformity	This device conforms to the safety regulations of the EMC directive 2014/30/EU and of NSR 2014/35/EU.

Product overview

Type of installation	Channel	Operating voltage	Colour	Type	Item number
Ceiling installation	Light HVAC	230 V AC	White	thePrema S360 -101 E	2070605
Ceiling installation	Light HVAC	230 V AC	Grey	thePrema S360 -101 E	2070606
Ceiling installation	Light HVAC	230 V AC	Special colour in accordance with customer information	thePrema S360 -101 E	2070608

Troubleshooting

Fault	Cause
Light does not switch on and/or off if presence is detected and in darkness	Lux value is set too low; detector set on semi-automatic; light was switched off manually via push button or theSenda S; person not within detection area; obstruction(s) interrupting detection; time delay set too short
Light stays on with detection of presence despite sufficient brightness	Lux value is set too high; light was briefly switched on manually via push button or with theSenda S (wait 30 min.); detector is in test mode
Light does not switch off and/or light switches on spontaneously when no one is present	Wait for time delay (self-learning); thermal sources of interference in the detection area: fan heaters, incandescent lamps/halogen spotlights, moving objects (e.g. curtains hanging in an open windows); Load (EBs, relays) not cleared
Push button does not function	Device still in the start-up phase; illuminated push button was used without neutral conductor; Push button not led to the master
Light cannot be switched off with the push button	DIP switch to "corridor" position; push button not fed to the detector. Check wiring to the push button
Device does not respond	Short circuit or several phases in parallel switching! Disconnect detector from the power supply for 5 mins. (thermal fuse)
Error flashing (4 x per second)	Error in self-test; Device not properly functional!

Guarantee

ThebenHTS presence detectors are manufactured with the utmost care and using state-of-the-art technology and are quality-tested. ThebenHTS AG therefore guarantees perfect operation when used correctly. Should a fault occur, however, ThebenHTS AG will fulfil the guarantee within the scope of the general terms and conditions.

Please note in particular:

- that the guarantee period lasts 24 months from the date of manufacture.
- that the guarantee is invalidated if you, or a third party, make changes or undertake repairs to the devices.
- that, insofar as the presence detectors are connected to a software-controlled system, the guarantee for this connection is only valid when the indicated interface specification is complied with.

We undertake to repair or replace as quickly as possible all components of the delivered device that have become defective or unusable through demonstrably poor material, faulty construction or incomplete delivery up to the end of the guarantee period.

Returns

In the event of a guarantee claim, please return the device to the relevant dealer together with the delivery note and a brief description of the fault.

Industrial property rights

The design as well as hardware and software of these devices are protected by copyright.

Dimensions diagrams

Flush-mounting

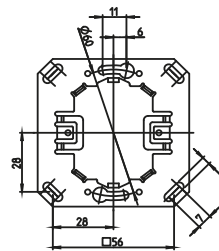
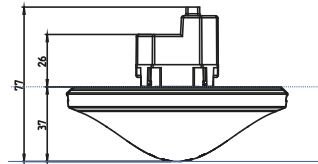

Surface-mounted

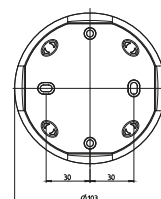
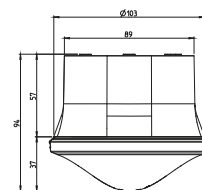

Ceiling installation

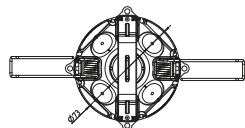
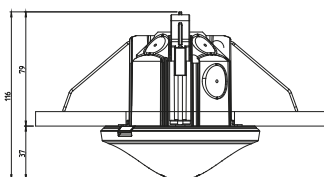

Back box (surface mounting) 110A

Item No.: 9070912

[Details > www.theben.de](http://www.theben.de)



Ceiling installation box 73A

Item No.: 9070917

[Details > www.theben.de](http://www.theben.de)



SendoPro 868-A

Item No.: 9070675

[Details > www.theben.de](http://www.theben.de)



theSenda S

Item No.: 9070911

[Details > www.theben.de](http://www.theben.de)



theSenda P

Item No.: 9070910

[Details > www.theben.de](http://www.theben.de)



ThebenHTS AG

Im Langhag 7b

8307 Effretikon

SWITZERLAND

Phone +41 52 355 17 00

Fax +41 52 355 17 01

Hotline

Phone +41 52 355 17 27

hotline@theben-hts.ch

Addresses, telephone numbers, etc.

www.theben-hts.ch