

EN Presence detector

theRonda S360-100 DE WH

2080560

theRonda S360-100 FLAT DE WH

2080540

theRonda S360-100 AP WH

2080550

theRonda S360-100 AP GR

2080551



1. Product characteristics

- Passive infrared presence detector for ceiling installation
- Circular detection area 360°, up to Ø 9 m (64 m²)
- Automatic presence- and brightness-dependent control for lighting
- Mixed light measurement suitable for fluorescent lamps (FL/PL/ESL), halogen/incandescent lamps and LEDs
- Channel A light: relay, 230 V
- Operation as fully automatic device
- Brightness switching value configurable, teach-in function
- Pulse function for staircase light timer switch
- Time delay configurable
- Detection sensitivity configurable
- Ready for immediate use due to factory presetting
- Test mode for checking function and detection area
- Installation in false ceilings with springs, type DE
- Ceiling installation surface mounted, type AP
- User remote control "theSenda S" (optional)
- Management remote control "SendoPro" (optional)
- Service remote control "theSendaP" (optional)
- App remote control „theSenda B" (option) and corresponding app „theSenda Plug" (iOS/Android)

2. Safety



WARNING

Danger of death through electric shock or fire!

- Installation should only be carried out by a qualified electrician!

- Work on electrical systems may only be carried out by qualified electricians or by instructed persons under the guidance and supervision of a qualified electrician in accordance with the technical regulations applying to electricity!
- Comply with the country-specific safety regulations for work on electrical systems! Ensure absence of voltage in the cable before installation!
- The device is maintenance-free. If the device is opened or penetrated with any object, the guarantee lapses.

3. Proper use

The presence detector is intended for indoor installation. The presence detector is exclusively intended for the use as contractually agreed between the manufacturer and the user. Any other use is considered to be unacceptable. The manufacturer does not accept liability for any resulting damages.

4. Operation

The presence detector is primarily used in offices, corridors, stairs, toilets, basements and garages as well as in homes for easy and energy-efficient control of lighting. The switch contact "light" switches lighting on with presence and insufficient brightness, and off with absence or sufficient brightness.

Function description

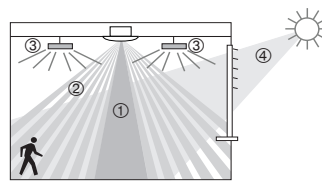

- ① Mixed light measurement
- ② Presence detection
- ③ Artificial light
- ④ Incident daylight

Channel A light

Switching response is controlled by presence and brightness. The switch contact for Channel A light closes during darkness and when someone is present. It opens with a delay when there is brightness or once the room is vacated after the set time delay.

Time delay

The time delay enables delayed switching off of lighting after the room is vacated. The time delay is adjustable in a range of 10s to 60min.

Fully automatic device

Lighting control of the presence detector operates fully automatically for increased comfort. The lighting switches on and off automatically as a "fully automatic device".

Pulse function

Time delay can be set to pulse for controlling existing staircase light timer switches. To do so, the light output produces a pulse of 0.5s in duration every 10 seconds if people are present or it is dark.

5. Detection area

The circular detection area of theRonda S presence detector covers an average detection area. Note that seated persons are detected in different sized areas. The recommended installation height is 2 m – 4 m. As installation height increases, the sensitivity of the presence detector decreases. The extent and distance between the active and passive zones of the

presence detector also increases. The detection range is reduced as the temperature increases.

Seated people

The presence detector reacts very sensitively to the slightest movements. The details refer to smallest movements at table height (approx. 0.80 m). The detection sensitivity is reduced from an installation height of > 3 m. More pronounced movements are required for clear detection.

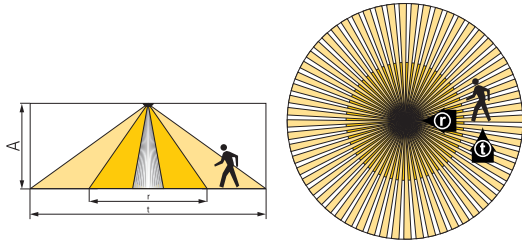

Installation height (A)	Across (t)	Frontal (r)	Seated (s)
2.0m	Ø 7.0m (38m ²)	Ø 2.5m (5m ²)	Ø 2.5m (5m ²)
2.5m	Ø 7.0m (38m ²)	Ø 3.0m (7m ²)	Ø 3.0m (7m ²)
3.0m	Ø 8.0m (50m ²)	Ø 4.0m (13m ²)	Ø 4.0m (13m ²)
3.5m	Ø 8.0m (50m ²)	Ø 4.0m (13m ²)	–
4.0m	Ø 9.0m (64m ²)	Ø 4.0m (13m ²)	–

All figures are guidance values (detection areas according to sensNORM IEC 63180, see data sheet).

Brightness measurement

The presence detector measures artificial light and daylight that is reflected below the detector. The light measurement area maps a rectangle of about 1.8 x 3 m at table height. The installation location is the reference point for the lighting level. Direct light influences the light measurement.

- Avoid placing floor lamps or suspended lighting directly below the detector.

If the brightness measurement is deactivated, the channel A light only switches depending on the presence (brightness switching value set to "measurement off" via the remote control).

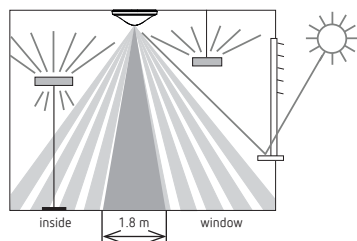

Suitable lamps

The presence detector is designed for the operation of fluorescent lamps, compact fluorescent lamps, halogen/incandescent lamps and LEDs. The maximum number of switchable lights is restricted due to the high inrush current levels of the EBs and LED drivers. The use of an external contactor helps with large loads. All switched loads must be properly suppressed.

6. Installation

Ceiling installation

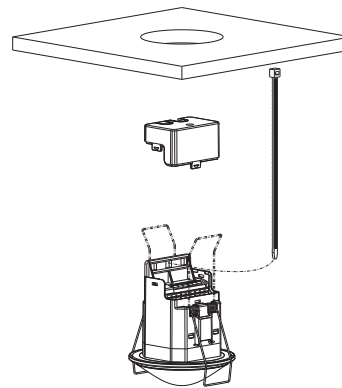

Installation in false ceilings for ceiling thicknesses of 0.5mm to 3cm. The diameter of the ceiling cutout must be between 62mm and 70mm. The cable strain relief is implemented using a cable tie (width: 3.5 – 4.8mm).

The detector requires a clear line of sight to people. The installation height must not be below 1.7m and not higher than 4 m.

Ceiling installation - surface mounted

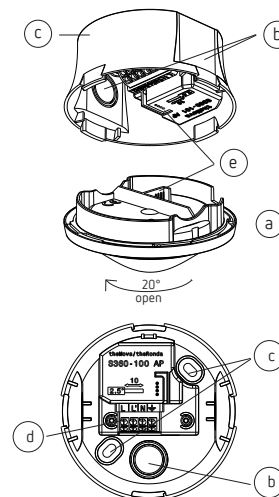

- Turn the sensor unit (a) by about 20° counterclockwise, up to the snap-in point.
- Remove the sensor unit.
- Break out the required cable passages (b).
- Mount the power supply unit (c) on the ceiling using the provided fastening holes (c).
- Wiring in accordance with the label on the plug-in terminal, cable cross section 0.25 – 2.5mm² (d)
- Affix the sensor unit (a) paying attention to the plug-in connection (e).

7. Switching

The presence detectors can be operated as a Master in individual switching. With parallel switching of the light outputs (L'), it must be ensured that all detectors connected in parallel are connected to the same phase.

Individual switching

In individual switching, the presence detector, as Master, detects presence and brightness and controls lighting.

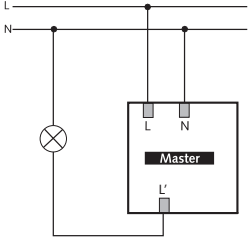

8. Settings

The presence detector theRonda S does not have a potentiometer. The presence detectors are supplied with basic settings ready for operation. The specifications are guidance values. Management remote control „SendoPro 868-A“, service remote control „theSenda P“ and app remote control „theSenda B“ (with „theSenda Plug“ app) are available for start-up. They allow the remote adjustment of the setting values.

Parameters via remote control

The following parameters can be queried or changed via the remote control for support during installation as well as servicing:

Parameters	Description	Can be queried by SendoPro 868-A / theSenda B (app)	Can be changed by SendoPro 868-A / theSenda B (app)	Can be changed theSenda P
Brightness switching value Channel A light	Value range in lux	x	x	x
	Measurement off	x	x	x
Brightness actual value Channel A light	Value range in lux	x		
Time delay Channel A light	Value ranges in seconds / minutes		x	x
	Pulse		x	x
Detection sensitivity (PIR)	Value range in increments		x	x
Group address Channel A light	All / I / II / III		x	
LED display motion	Off / On		x	

The parameters are sent to the presence detector via infrared by using the „SendoPro 868-A“ management remote control, the „theSenda P“ service remote control, or „theSenda B“ app remote control (with „theSenda Plug“ app). Changed parameters are immediately applied and used by the detector.

With the „SendoPro 868-A“ management remote control, as well as with „theSenda B“ app remote control (with „theSenda Plug“ app), parameters can be queried by sending values level-by-level to the detector. If the sent value is below the set parameter, the LED illuminates briefly. If the sent value is equal to or above the set parameter, the LED flickers for 2 seconds.

Control commands via remote control

Control command	Description	Can be triggered by SendoPro 868-A / theSenda B (app)	Can be triggered theSenda P
Teach-in Channel A light	Activation	x	x
Switching light	Lighting group can be switched on and off.	x	x
Presence test	On / Off	x	x
Restart	Restart detector	x	x
Factory settings	Set all parameters and settings to factory setting.	x	

Brightness switching value Channel A light

The brightness switching value defines the minimum desired brightness. The currently prevailing brightness is measured below the presence detector. If the prevailing brightness is below the switching value, the light switches on as soon as a presence is detected.

Value range

Adjustable values "SendoPro 868-A" / "theSenda B" (app)	30–3000 lux
Adjustable values "theSenda P"	30, 300, 500, 800 lux

Deactivation of brightness measurement (brightness measurement has no effect) The light channels only switch according to presence and absence.	
"SendoPro 868-A" / "theSenda B" (app)	Measurement off
"theSenda P"	Button ☀

Teach-in channel A light

During teach-in, the currently measured brightness value is accepted as brightness setpoint value A. Values outside the permitted range will automatically be set to the appropriate limit value.

"SendoPro 868-A" / "theSenda B" (app)	Teach-in
"theSenda P"	Button 👁

Time delay Channel A light

Value range



Adjustable values "SendoPro 868-A" / "theSenda B" (app)	10 s–60 min
Adjustable values "theSenda P"	10 s, 30 s, 60 s, 2 min, 10 min, 20 min, 60 min

Control for staircase light timer switch (0.5 s "on" / 10 s "off")	
"SendoPro 868-A" / "theSenda B" (app)	Pulse
"theSenda P"	Button 

Detection sensitivity

The detector has 5 sensitivity increments. The basic setting is the middle increment (3).

With the „SendoPro 868-A“ management remote control, as well as with „theSenda B“ app remote control (with „theSenda Plug“ app), the increments 1 to 5 can be selected and sent to the detector.

With the „theSenda P“ installation remote control, the sensitivity can be decreased  or increased  by one increment each time the button is pushed.

Increment	Sensitivity
1	very insensitive
2	insensitive
3	Standard
4	sensitive
5	very sensitive

Group address Channel A light

This parameter is applied when using the „theSenda S“ user remote control.

A group address can be assigned to channel A light.

The group addresses can be programmed with the following remote controls:

Group address value range

Adjustable values "SendoPro 868-A"	I, II, III, All
Adjustable values "theSenda B"	I, II, III
Adjustable values "theSenda Plug"	I–VIII, All
Adjustable values "theSenda S"	I, II

LED display motion

The motion detection can be displayed via the LED.

Value range (only with management remote control SendoPro 868-A/theSenda B (App))

No display of motion detection.	Off
The LED is switched on when motion is detected, otherwise switched off.	On

Factory settings

The theRonda S360-100 presence detector is supplied with the following parameter values:

Parameters	Value
Brightness switching value Channel A light	300 lux
Time delay Channel A light	10min
Channel H presence time delay	10min
Detection sensitivity (PIR)	Increment 3
Group address Channel A light	I
LED display motion	Off

9. Start-up

Switch-on behaviour

Every time the power supply is switched on, the presence detector first runs through a start-up phase of 30s, and then switches to normal operation. An LED displays the current status:

1. Start-up phase (30s)

- The red LED flashes at one second intervals, the switch contact is closed (light on).
- The detector does not react to remote control commands.
- When no one is present, both contacts open after 30s.

2. Operation

The detector is ready for operation (LED off).

Presence test

The test mode detection area is used to test presence detection and wiring. Presence test mode can be activated with „SendoPro 868-A“ management remote control, with „theSenda B“ app remote control (with „theSenda Plug“ app) and with „theSenda P“ installation remote control.

Setting test mode detection area with remote control

- The detector goes directly into test mode when the test mode is set via the remote control:
 - Every movement is indicated by the LED.
 - When movement occurs, the light switch contact closes.
 - When no one is present, the light switch contact opens after 10 seconds.
 - Brightness measurement deactivated, detector does not react to brightness.
 - Teach-in cannot be activated in test mode.
- Test mode ends automatically after 10min.

The detector restarts itself (see switch-on behaviour).

10. Technical Data

Operating voltage	230V AC +- 10%
Frequency	50Hz
Upstream protection device:	13A
Power consumption	approx. 0.5W
Type of installation	Ceiling installation
Recommended installation height	2,0 – 3,0 m / max. 4 m
Minimum height	> 1.7m
Detection area	horizontal 360°
Maximum range	Ø 4m (Mh. 3m) / 13m ² seated Ø 4m (Mh. 3m) / 13m ² radially moving Ø 8m (Mh. 3m) / 50m ² tangentially moving
Setting range brightness switching value	30 – 3000 lux
Lighting time delay A light	10s – 60min/pulse
Channel A light	Relay 230V / 10A, µ-contact
Max. switching capacity cos φ 1 resistive	2300W
Max. switching capacity cos φ 0.5	1150VA
Max. switching capacity LED	see manufacturer concerning cos φ
Guide values	
LED lamps < 2 W	25 W
LED lamps ≥ 2 W	70 W

Guidance value max. inrush current level	400A / 200µs
Maximum number EBs T5/T8	10 x 54/58W, 16 x 35/36W 5 x 2 x 54/58W 8 x 2 x 35/36W
Connection type	Plug-in terminals
Max. cable cross-section	max. 2.5mm ²
Protection rating: theRonda S360-101 DE	IP 20 (IP 54 installed)
Protection rating: theRonda S360-101 AP	IP 54
Ambient temperature	-15°C to +50°C
CE Declaration of Conformity	This device conforms to the safety regulations of the EMC directive 2014/30/EC and of directive 2014/35/EC.

Dimensions diagrams

theRonda S360-100 DE

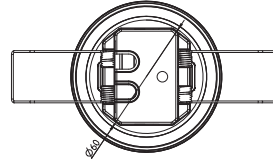
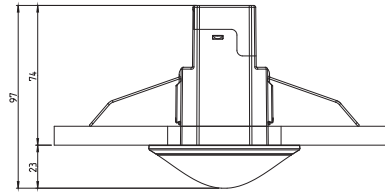

theRonda S360-100 FLAT DE

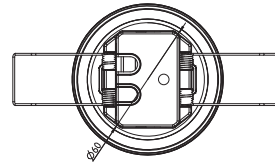
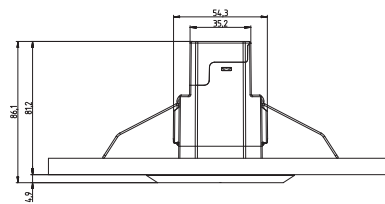

theRonda S360-100 AP

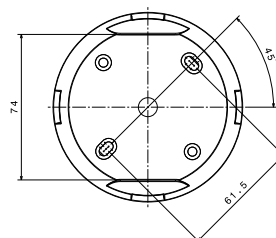
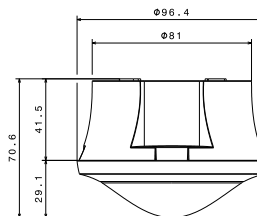

Product overview

Type of installation	Channel	Operating voltage	Colour	Type	Item number
Ceiling installation	Light	230V AC	White	theRonda S360 -100 DE WH	2080560
Ceiling installation	Light	230V AC	White	theRonda S360-100 FLAT DE WH	2080540
Ceiling installation	Light	230V AC	White	theRonda S360-100 AP WH	2080550
Ceiling installation	Light	230V AC	Grey	theRonda S360-100 AP GR	2080551
Ceiling installation	Light	230V AC	Special colour in accordance with customer information	theRonda S360-100 AP SF	2080553

Troubleshooting

Fault	Cause
Light does not switch on if presence is detected and in darkness	Lux value is set too low; light was switched off via theSenda S; person not within detection area; obstruction(s) interrupting detection; time delay set too short
Light does not switch off and/or light switches on spontaneously when no one is present	Wait for time delay; thermal sources of interference in the detection area: fan heaters, incandescent lamps/halogen spotlights, moving objects (e.g. curtains hanging in open windows); Load (EBs, relays) not cleared
Error flashing (4 x per second)	Error in self-test; Device not properly functional!

LED display

LED	Description
Flashing at 1 second intervals	The presence detector is in the start-up phase.
Flickering for 2s	The command sent from the remote control via infrared was accepted by the presence detector.
Lighting up briefly	The command sent from the remote control via infrared was rejected by the presence detector. The command is not valid. Check the selected detector type or parameters on the SendaPro or in the app.
Fast flashing	Error flashing; The presence detector has found an error.
Lights up or flickers irregularly	The presence detector is in detection area test mode or "LED display movement" is activated. The LED displays detection of movement.

11. Accessories

theSenda B

Item No.: 9070985

[Details > www.theben.de](#)

theSenda S

Item No.: 9070911

[Details > www.theben.de](#)

theSenda P

Item No.: 9070910

[Details > www.theben.de](#)

12. Contact

Theben AG

Hohenbergstraße 32

72401 Haigerloch

GERMANY

Phone: +49 7474 692-0

Fax: +49 7474 692-150

Hotline

Phone: +49 7474 692-369

hotline@theben.de

www.theben.de